

# Cezar<sup>®</sup>

PERFECTION  
in DETAILS

[www.cezar.eu](http://www.cezar.eu)



## ZASTOSOWANIE / ПРИМЕНЕНИЕ / APPLICATION

Listwy przypodłogowe Elegance z polistyrenu ekstrudowanego to nowy produkt, który szybko zdobywa uznanie wśród nawet najbardziej wymagających użytkowników. Oprócz eleganckiego wyglądu listwy Elegance możemy zaliczyć możliwość malowania jej na dowolny kolor lub po prostu malowania na ten sam kolor co ścianę. Wówczas listwa tworzy ze ścianą swego rodzaju monolit, co wygląda bardzo efektownie. Kolejnymi zaletami są odporność listwy na wilgoć, maskowanie kabli urządzeń medialnych oraz zakończeń tapet, trwałość. Dodatkowo listwy Elegance są proste w docinaniu i montażu, a po zainstalowaniu tworzą niewidoczne połączenia. Listwy montowane są za pomocą szybko schnącego kleju do sztukaterii – Creativa.

Напольный плинтус Элеганс из полистирола – это новый продукт, который быстро завоевал сердца даже самых привередливых покупателей. Кроме элегантной формы плинтус имеет много дополнительных достоинств, среди которых, к примеру, возможность покраски плинтуса в любой цвет или в тот же самый, что и стена. В этом случае плинтус выглядит эффектно, как неотъемлемая часть стены. Очередные достоинства – устойчивость плинтуса к влажности, маскировка различных проводов, а также концов обоев, прочность. Также плинтусы Элеганс просто подогнать по размеру и монтировать, при этом места их стыков невидимы. Плинтусы крепятся к стене с помощью быстро сохнущего клея Креатива для лепного декора.

Elegance skirting boards made from extruded polystyrene are the new products successfully winning recognition among most demanding users. Apart from elegant appearance, there are more advantages to it, like possibility of painting it any colour or simply the same colour as a wall. Then the skirting would create a kind of monolith with an attractive look. Other advantages are resistance to humidity, masking of cables for media applications and finish of wallpapers, durability. Additionally Elegance skirting boards are simple in cutting and assembling, and after installation they create invisible connection lines. Elegance skirting boards are installed with the use of fast drying adhesive for stuccowork – Creativa.



malowanie na dowolny kolor  
painting in any colour  
покраска в любой цвет



malowanie ze ścianą  
painting together with the wall  
покраска вместе со стенами



proste cięcie  
simple cutting  
легко режется



niewidoczne połączenia  
invisible joints  
невидимые соединения



produkt odporny na wilgoć  
product resistant to humidity  
влагостойкая продукция

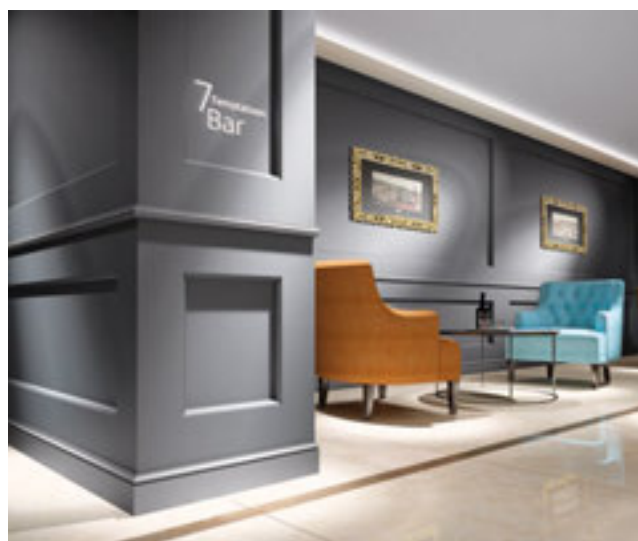



### ZASTOSOWANIE / ПРИМЕНЕНИЕ / APPLICATION

Listwy przypodłogowe Elegance do taśm LED to nowość w ofercie firmy Cezar. Listwy z polistyrenu ekstrudowanego posiadają dodatkowy kanał do umieszczenia taśmy LED, dzięki czemu zyskujemy nowoczesny i stylowy produkt. Delikatne oświetlenie wnętrza pomieszczenia podnosi jego walory estetyczne, a także oświetla drogę przy zgaszonym głównym świetle, chroniąc przed potknięciem się i upadkiem. Listwy cechuje łatwy montaż, niewidoczne połączenia, trwałość i odporność na wilgoć.

Напольные плинтусы Elegance для светодиодных лент – новинка в ассортименте фирмы Цезарь. Плинтусы из экструдированного полистирола имеют дополнительный канал для размещения светодиодной ленты, благодаря чему вы приобретаете современный и стильный продукт. Мягкая подсветка помещения улучшает его эстетический вид, а также подсвечивает путь при отсутствии основного освещения, предотвращает спотыкания и падения. Основными характеристиками этих плинтусов являются: легкий монтаж, невидимые соединения, влагоустойчивость и солидность.

Skirting boards Elegance dedicated for LED strips are new products offered by Cezar. Our boards made from extruded polystyrene have an additional duct for LEDs strips - thanks to what we gain a modern and stylish product. Delicate lighting of the interior increase an aesthetic values and also illuminates the way when the main light is off - which protects us against trips and falls. Elegance LED moldings are characterized by easy assembly, invisible joints, durability and resistance to moisture.

	NR KAT. / KAT. № / CAT. NO			
	19LE	29LE	↔	↔
101	654978	654954	2,44 m	18
T101	654961	654947	2,44 m	18

### WYMIARY / РАЗМЕР / DIMENSIONS

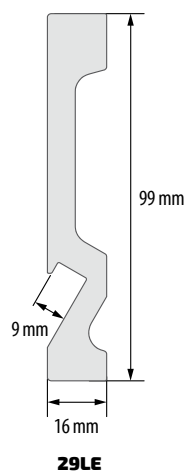
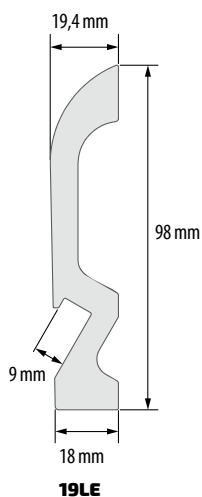



## ZASTOSOWANIE / ПРИМЕНЕНИЕ / APPLICATION

Listwy przypodłogowe Elegance z polistyrenu ekstrudowanego wykonane są nowoczesną technologią. Oferują kolorystykę zgodną z najnowszymi trendami wzornictwa.

Напольные плинтусы Элеганс из экструдированного полистирола изготовлены с помощью современной технологии. В наличии цвета, подобранные в соответствии с последними трендами дизайна.

Elegance skirting boards made of extruded polystyrene are made with modern technology. Offering colours in line with the latest design trends.

	NR KAT. / KAT. № / CAT. NO					
	LPC-06	LPC-11	LPC-20	LPC-23	↔	↕
117	661501	661600	661747	661839	2,44 m	28
125	661518	661648	661754	661846	2,44 m	28
128	661525	661655	661761	661853	2,44 m	28
146	661532	661679	661785	661860	2,44 m	28
149	661549	661686	661792	661877	2,44 m	28
153	661556	661716	661808	661884	2,44 m	28
168	661563	661723	661822	661891	2,44 m	28
169	668333	668326	668340	666254	2,44 m	28

## KOLORYSTYKA / ЦВЕТОВАЯ ГАММА / RANGE OF COLOURS



**117**  
Skórzany Pikowany Brąz  
Quilted Brown leather  
Стеганая коричн. кожа



**125**  
Dąb Szkocki  
Scottish Oak  
Дуб шотландский



**128**  
Francuski Kanton  
French cantone  
Французский кантон



**146**  
Brzoza Sandal  
Sandal Birch  
Береза сандал



**149**  
Dąb Carpenter Ciemny  
Dark Carpenter Oak  
Дуб Карпентер темн.



**153**  
Sosna Monrepo  
Monrepo Pine  
Сосна Монрепо



**168**  
Drewno rustykalne  
Rustic Wood  
Рустикальное дерево



**169**  
Drewno rustykalne szare  
Grey Rustic Wood  
Серое рустикальное дерево

## WYMIARY / РАЗМЕР / DIMENSIONS

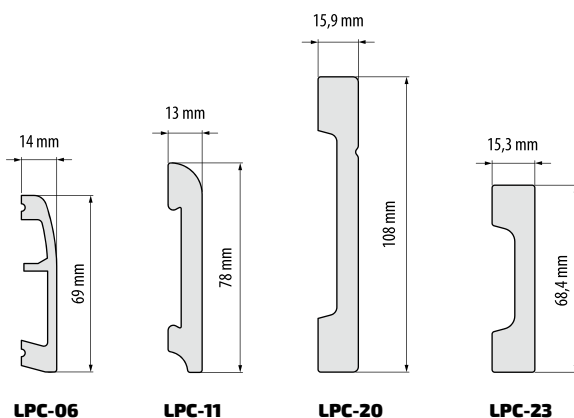

## KOLORYSTYKA LISTEW PRZYPODŁOGOWYCH ELEGANCE

### ЦВЕТОВАЯ ГАММА ПЛИНТУСОВ ELEGANCE

### RANGE OF COLOURS – ELEGANCE SKIRTING BOARDS



**101**  
Biały  
Белый  
White



**T101**  
Biały satyna  
Белый сатин  
White sateen



**Listwę należy pomalować!**  
Плинтусы следует покрасить!  
Skirting boards must be painted!



**Listwy nie malować!**  
Плинтусы не красить!  
Do not paint skirting boards!



Do malowania listew należy używać farb akrylowych i lateksowych.  
Для покраски плинтусов следует использовать акриловые и латексные краски.  
Paint skirting boards with acrylic and latex paints.



Srebrny szczotkowany  
Серебряный брашир.  
Brushed silver



Szampań szczotkowany  
Шампань брашированный  
Brushed champagne



### LPC-01

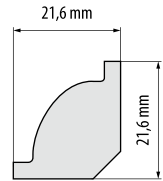

NR KAT. / KAT. № / CAT. NO



101

898914

2,44 m

100

T101

862342\*

2,44 m

100



\* Do wyczerpania zapasów / Товар доступен до  
окончания запасов на складе / Till stock lasts



### LPC-04

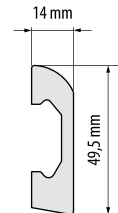

NR KAT. / KAT. № / CAT. NO



101

898945

2,44 m

40

T101

862359





2,44 m

40

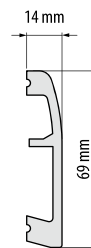

## LPC-06







NR KAT. / KAT. № / CAT. NO			
			
101	898969	2,44 m	30
T101	862366	2,44 m	30
148	898976	2,44 m	30
150	898983	2,44 m	30

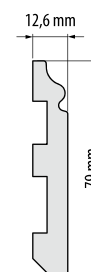

## LPC-07







NR KAT. / KAT. № / CAT. NO			
			
101	625640	2,20 m	25
101	898990	2,44 m	25
101	 612008	2,44 m	25
T101	862373	2,44 m	25

 Listwa z zaaplikowanym klejem / Плинтус с нанесенным клеем / Plinth with applied glue

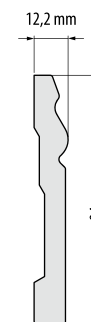

## LPC-08



NR KAT. / KAT. № / CAT. NO			
			
101	899003	2,44 m	23
T101	862380	2,44 m	23



## LPC-09

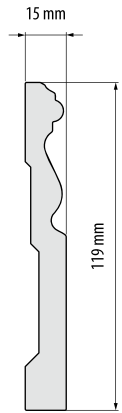

NR KAT. / KAT. № / CAT. NO			
101	899010	2,44 m	16
T101	862397	2,44 m	16



## LPC-10

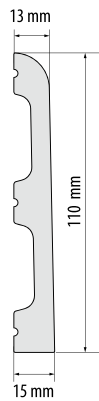

NR KAT. / KAT. № / CAT. NO			
101	654060	2,44 m	18
T101	654053	2,44 m	16
148	654039	2,44 m	16
150	654046	2,44 m	16



## LPC-11

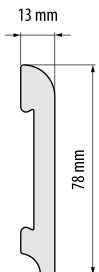

NR KAT. / KAT. № / CAT. NO			
101	899027	2,44 m	28
101	612121	2,44 m	28
T101	862403	2,44 m	28
148	899034	2,44 m	28
150	899041	2,44 m	28

Listwa z zaaplikowanym klejem / Плинтус с нанесенным клеем / Plinth with applied glue



## LPC-12

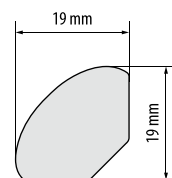



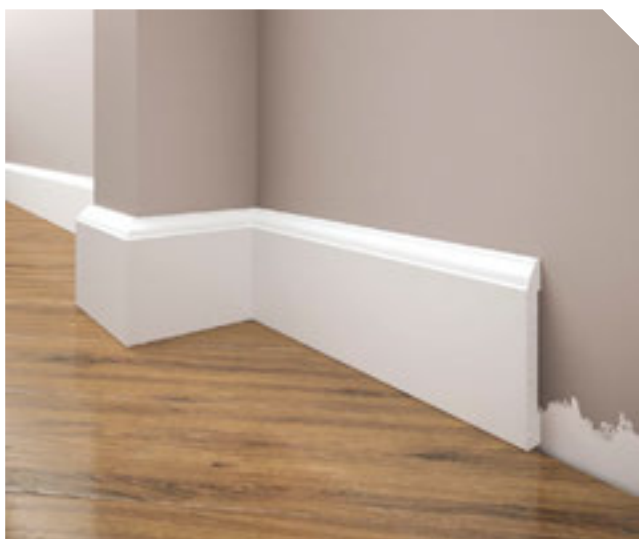

NR KAT. / KAT. № / CAT. NO			
			
101	899058	2,44 m	100

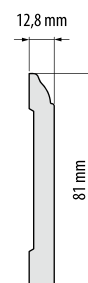

## LPC-15







NR KAT. / KAT. № / CAT. NO			
			
101	899089	2,44 m	29
101	 612152	2,44 m	29
T101	862427	2,44 m	29

 Listwa z zaaplikowanym klejem / Плинтус с нанесенным клеем / Plinth with applied glue

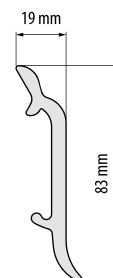

## LPC-16



NR KAT. / KAT. № / CAT. NO			
			
101	899096	2,44 m	27
T101	862434	2,44 m	27
-	899102		100

## LPC-16C

klips montażowy  
installation clip  
монтажный зажим



NR KAT. / KAT. № / CAT. NO			
			
-	899102		100



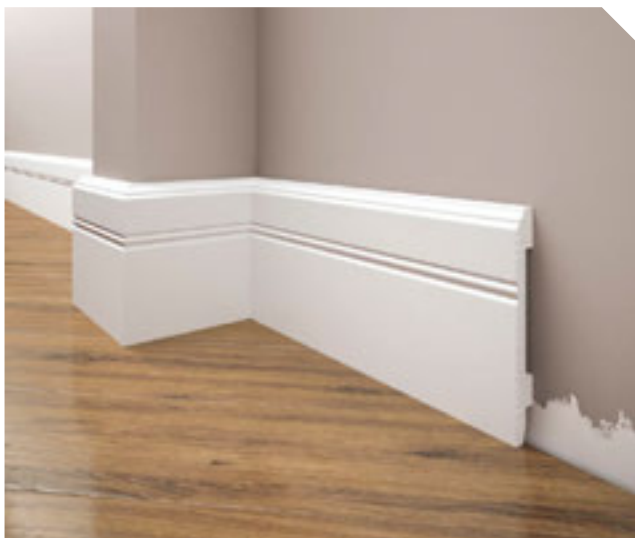

## LPC-18

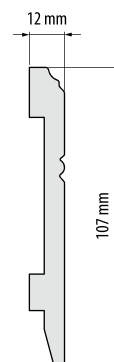

NR KAT. / KAT. № / CAT. NO			
101	899119	2,44 m	25
T101	862441	2,44 m	25



## LPC-19

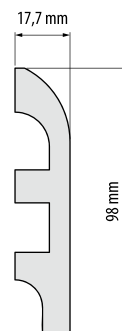

NR KAT. / KAT. № / CAT. NO			
101	899126	2,44 m	16
T101	862458	2,44 m	16



## LPC-20

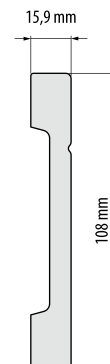





NR KAT. / KAT. № / CAT. NO			
101	625657	2,20 m	18
101	899133	2,44 m	18
101	612190	2,44 m	18
T101	862465	2,44 m	18
148	899140	2,44 m	18
150	899157	2,44 m	18

Listwa z zaaplikowanym klejem / Плинтус с нанесенным клеем / Plinth with applied glue

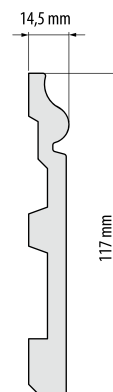

## LPC-22







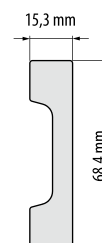

NR KAT. / KAT. № / CAT. NO			
			
101	625664	2,20 m	16
101	899171	2,44 m	16
T101	862472	2,44 m	16



## LPC-23







NR KAT. / KAT. № / CAT. NO			
			
101	625671	2,20 m	27
101	899188	2,44 m	27
101	 612213	2,44 m	27
T101	862489	2,44 m	27
148	899195	2,44 m	27
150	899201	2,44 m	27

 *Listwa z zaaplikowanym klejem / Плинтус с нанесенным клеем / Plinth with applied glue*

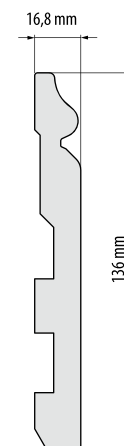

## LPC-24







NR KAT. / KAT. № / CAT. NO			
			
101	899218	2,44 m	12
T101	862496	2,44 m	12

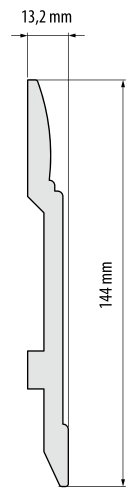

## LPC-25







NR KAT. / KAT. № / CAT. NO			
			
101	899225	2,44 m	15
T101	862502	2,44 m	15

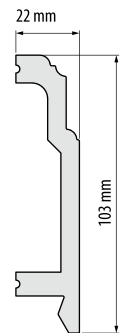

## LPC-26







NR KAT. / KAT. № / CAT. NO			
			
101	899232	2,44 m	14
T101	862519	2,44 m	14

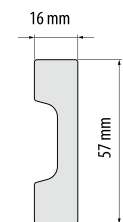

## LPC-27







NR KAT. / KAT. № / CAT. NO			
			
101	863110	2,44 m	30
T101	863141	2,44 m	30

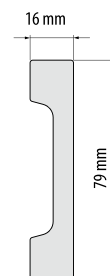

## LPC-28







NR KAT. / KAT. № / CAT. NO			
			
101	863127	2,44 m	25
T101	863158	2,44 m	25

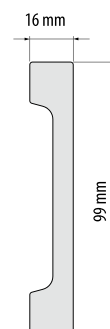

## LPC-29







NR KAT. / KAT. № / CAT. NO			
			
101	863219	2,44 m	18
T101	863226	2,44 m	18

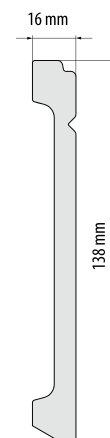

## LPC-30





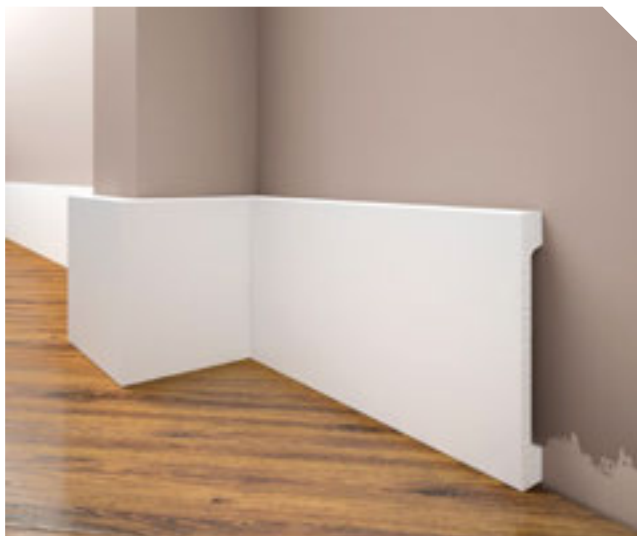

NR KAT. / KAT. № / CAT. NO			
			
101	863271	2,44 m	14
T101	863288	2,44 m	14

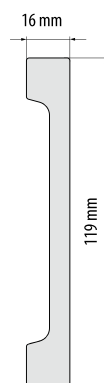

## LPC-31





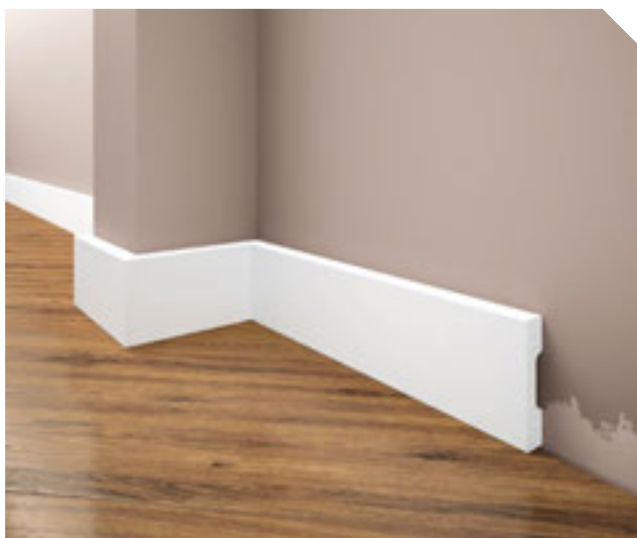

NR KAT. / KAT. № / CAT. NO			
			
101	863608	2,44 m	15
T101	863622	2,44 m	15

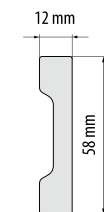

## LPC-32



NR KAT. / KAT. № / CAT. NO			
			
101	617324*	2,44 m	42
T101	617331*	2,44 m	42







\* Do wyczerpania zapasów / Товар доступен до  
окончания запасов на складе / Till stock lasts

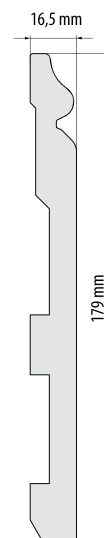

## LPC-33







NR KAT. / KAT. № / CAT. NO			
			
101	863721	2,44 m	10
T101	863745	2,44 m	10

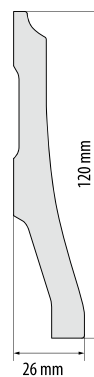

## LPC-34



NR KAT. / KAT. № / CAT. NO			
			
101	611094*	2,44 m	14
T101	611124*	2,44 m	14





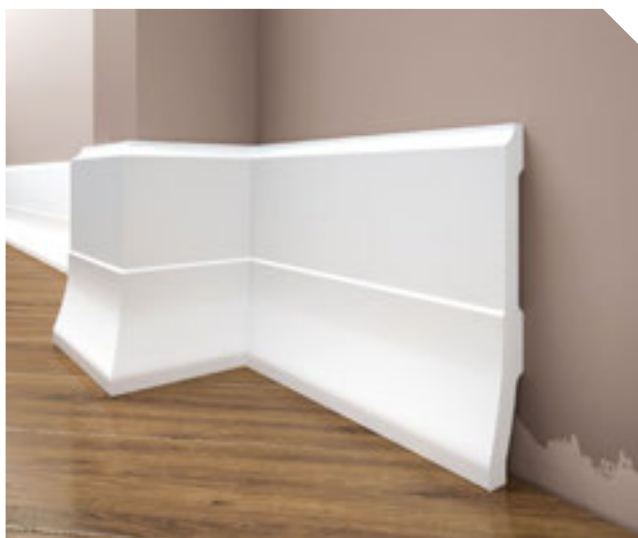

\* Do wyczerpania zapasów / Товар доступен до  
окончания запасов на складе / Till stock lasts

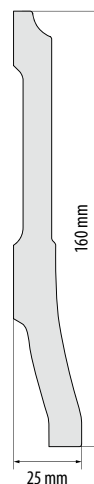

## LPC-35







NR KAT. / KAT. № / CAT. NO			
			
101	611155	2,44 m	14
T101	611162	2,44 m	14

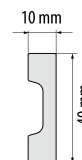

## LPC-36



NR KAT. / KAT. № / CAT. NO			
			
101	602597	2,44 m	70
T101	602603	2,44 m	70



## LPC-37

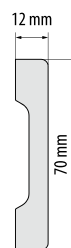

NR KAT. / KAT. № / CAT. NO			
101	611407	2,44 m	33
T101	611438	2,44 m	33



## LPC-38



NR KAT. / KAT. № / CAT. NO			
101	611445	2,44 m	24
T101	611452	2,44 m	24



## LPC-39

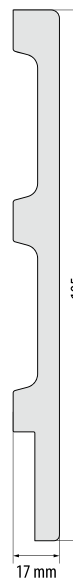

NR KAT. / KAT. № / CAT. NO			
101	611933	2,44 m	9
T101	611940	2,44 m	9

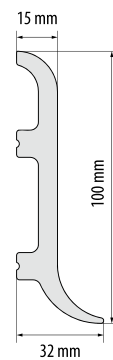
**LPC-40**

NR KAT. / KAT. № / CAT. NO			
101	602726	2,44 m	14
T101	602733	2,44 m	14

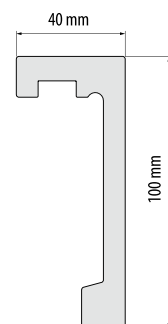
**LK-01**

NR KAT. / KAT. № / CAT. NO			
B101	664687	2,44 m	10
BT101	664694	2,44 m	10

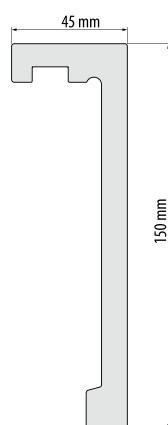
**LK-02**

NR KAT. / KAT. № / CAT. NO			
B101	664700	2,44 m	6
BT101	664731	2,44 m	6

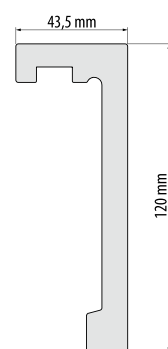
**LK-03**

NR KAT. / KAT. № / CAT. NO			
B101	664755	2,44 m	7
BT101	664793	2,44 m	7

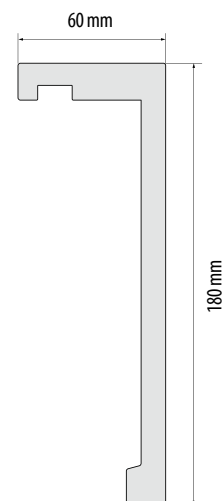
**LK-04**

NR KAT. / KAT. № / CAT. NO			
B101	601880	2,44 m	4
BT101	601897	2,44 m	4