

# Acrovyn®

## Wall & Door Protection



DESIGN. DECORATE. PROTECT.



## CONSTRUCTION SPECIALTIES

# About Us

Established in 1948, Construction Specialties is a family-owned business with 22 offices worldwide and has key manufacturing locations or sales offices in most European countries.

Wherever you are, we can provide customers with fast local support from trained and experienced personnel.

As a manufacturer and supplier of specialist products, we have become a global leader in many of our product ranges, which have been successfully installed in some of the world's most prestigious buildings and across a wide spectrum of sectors.



### GLOBAL PRESENCE

CS developed Acrovyn Wall Protection over 50 years ago and has since been involved in thousands of successful projects around the world.



### INNOVATION

Many of our standard models and product innovations have been created through collaboration with our customers and responding to market needs. In 2004, we were the first manufacturer to introduce PVC-Free wall protection to the market.



### KNOWHOW

From early design stage and product selection to installation, we provide customers with advice and support to ensure successful project delivery.

# ACROVYN®

## Contents

### Why Acrovyn®?

NEW COLOUR PALETTE  
ACROVYN AND SUSTAINABILITY  
ACROVYN BACTERICIDE  
ACROVYN SHOWCASE

4

### Introduction to Wall Protection

GUIDANCE TO DESIGNING EFFECTIVE WALL PROTECTION SCHEMES

14

SPACES WORTH PROTECTING:

HEALTHCARE | CARE HOMES AND DEMENTIA CARE  
RETAIL | EDUCATION | FOOD RETAIL  
HOTELS | OFFICES & WORKPLACES  
SPORTS AND LEISURE | TRANSPORT

### Sheet & Panel Protection



ACROVYN TEXTURED SHEET - SOLID COLOURS  
ACROVYN TEXTURED SHEET - DECORATIVE FINISHES  
ACROVYN PVC-FREE TEXTURED SHEET  
ACROVYN SMOOTH SHEET  
ACROVYN BACTERICIDE SHEET  
ACROVYN STAINLESS STEEL SHEET  
ACROVYN BY DESIGN  
ACROVYN GLASS BY DESIGN  
ACROVYN WALL PANELS  
ACROVYN FP PANELS

### Corner Guards



### Handrails



---

Hand / Crash Rails



---

Crash Rails



---

Bed Head Protection



---

Stainless Steel Protection



---

EPDM Rubber Protection



---

Door Protection



---

**Our Services**

**146**

Colour Range Foldout

**148**

## Why Acrovyn®?

Wall protection has never looked better than with Acrovyn.

Offering limitless flexibility for designers, Acrovyn is renowned for its durability. It is available in many designer profiles and material options, an updated and extended palette of colours, finishes and textures to enhance and protect a wide spectrum of interiors.



### DESIGN

The Acrovyn Wall Protection range provides designers and facility owners with a comprehensive selection of design options to suit different requirements, budgets and applications. From healing healthcare environments to stimulating education facilities; aspirational hotels to inviting retail environments; energising leisure centres to unique fit-outs in the commercial sector, our products allow our customers the ability to create beautifully protected interiors that last.



### DECORATE

Acrovyn's new contemporary and decorative palette of colours, finishes and textures reflects interior design trends to work with any interior scheme. Our sheet protection can also incorporate high quality imagery and graphics, providing you with limitless opportunities to create unique and striking designs.



### PROTECT

Through-coloured and impact resistant Acrovyn Sheet provides a tough, durable and easy-to-clean finish to protect interior walls, doors, reception desks and other interior surfaces.

Robust Acrovyn Profiles protect walls and corners from damage, and are available in a wide choice of shapes, sizes, materials, colours and finishes to suit functional and aesthetic requirements.

For a complete and reliable protection solution for your interior, look no further than Acrovyn.



### EXPERIENCE

We've been supplying wall protection to thousands of customers internationally for over 50 years.

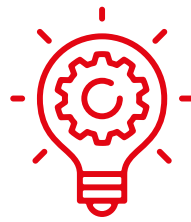

### INNOVATION

We are innovative in product design and in manufacturing, from our PVC-Free wall protection line to our patented Quick Lock brackets.



### THIRD PARTY TESTING

Our products' performance is backed by third-party testing.



### CUSTOMER SUPPORT

We support projects from design to completion stage offering specification support, design advice, site surveys and installation help.

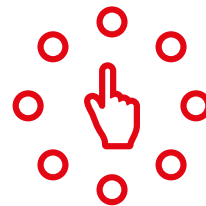

### WIDE PRODUCT RANGE

We offer a comprehensive range of wall protection profiles and flat protection options to suit different requirements, budgets and applications



## NEW COLOUR PALETTE

Colours, textures and finishes transform building interiors. They can impact our emotions and the way we perceive and experience spaces.

We have worked with Colour Consultants, specialists in the built environment, to develop a new colour offering which can be easily integrated into any design style.

The study included a thorough review of contemporary design schemes across all market sectors, current trends in materials and patterns, as well as detailed colour analysis.

Our refined palette of solid colours and expanded range of decorative finishes allows a multitude of ways to express your creativity and deliver beautiful interiors that last.



### REFRESHED OFFERING

From off-whites and pastels to dark, saturated colours, our range includes timeless classics and new on-trend shades to incorporate in your next design scheme.

Our brand new concrete patterns bring simplicity and depth to any interior, and will work equally well when combined with neutral shades, woodgrains or splashes of bright colours.

New Bronze and Copper iridescent metallics can be used for adding interest and sophistication to spaces.

For bringing warmth and a natural look to any interior, nothing beats woodgrain finishes. Now available in on-trend bleached effects, as well as traditional oak or walnut options.

For a truly bespoke look or a focal point, Acrovyn by Design murals can be utilised to bring patterns, colours and stunning imagery into any interior.

**Design. Decorate. Protect.**



---

## A COLOUR VISION

See wall protection in a whole new light with Acrovyn's updated palette of colours and finishes, which allows you to produce harmonious designs and create the ambience you desire.



Soft, natural shades and gentle pastels add calm, comfort and can be used to bring nature into your interiors. They are ideal for creating healing healthcare environments or relaxing spaces in any building type.



Vivid colours are synonymous with energy and vitality. Use them on feature walls, or to create bright and stimulating design schemes. They are also very effective as part of wayfinding schemes.

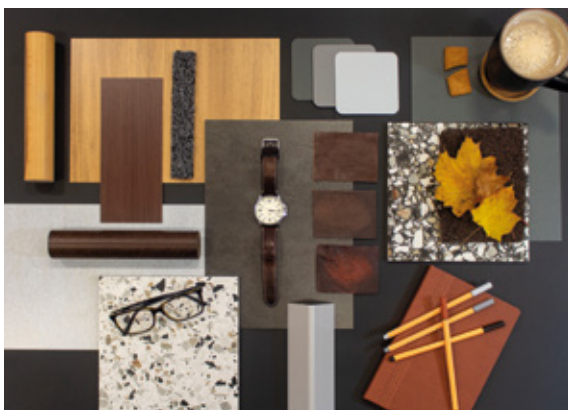

Choose from a selection of neutral shades in combination with concrete or woodgrain finishes to create classic and sophisticated spaces.

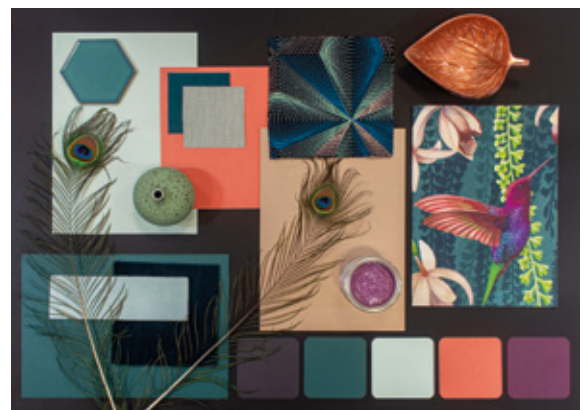

Our new deep shades work perfectly with metallic accents. Whether used on their own, or with complementary neutrals, they will bring a touch of comfort and luxury to your scheme.

For more colour inspiration visit [www.c-sgroup.eu/2445](http://www.c-sgroup.eu/2445)

## ACROVYN® AND SUSTAINABILITY

Protecting the environment is a journey, not a destination. CS recognises its responsibility to current and future generations for its role in the preservation of our global environment. We are proud of the contribution we make to sustainability and are continually working towards more environmentally-sound practices across our operations worldwide.



### SAFE FORMULATION

Acrovyn materials are free from persistent bio-accumulative toxins (PBTs), Bisphenol-A (BPA) and halogenated or brominated fire retardants.

When tested to ISO 16000 for the release of Volatile Organic Compounds, our products achieved an A+ rating.



### PVC-FREE SOLUTION

Acrovyn PVC-Free is our most environmentally friendly wall protection range and is proven to be as strong and durable as traditional Acrovyn.

Textured PVC-Free Sheet is B-s1, d0 fire rated (in accordance with EN 13501-1).



### CRADLE TO CRADLE CERTIFIED™ BRONZE\*

Newly awarded Bronze Level Cradle to Cradle certification for Acrovyn PVC-Free Sheet evaluates a product's sustainability across its entire lifecycle, giving customers confidence to specify it in green building schemes.



### ENVIRONMENTAL MANAGEMENT

Our main European operations in France, Germany, Italy, Spain and the UK are ISO 14001 certified, to ensure we continually measure and improve our environmental impact.

Certificate No: EMS 748572



### RESPONSIBLE MATERIAL SOURCING

We use wood from FSC- or PEFC-certified suppliers and our aluminium retainers are produced using up to 60% recycled aluminium content. Any factory metal waste is recycled or alternatively, custom lengths can be manufactured to reduce wastage.

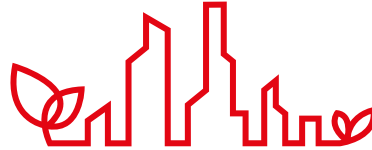

### GREEN BUILDING SCHEMES

Acrovyn products are designed to be robust, long lasting and to maximise the lifespan of the interior building fabric. They may contribute to sustainability schemes such as BREEAM or LEED.

For the latest information on our sustainability journey, visit [www.c-sgroup.eu/2907](http://www.c-sgroup.eu/2907)

\* Cradle to Cradle Certified™ is a registered trademark of the Cradle to Cradle Products Innovation Institute.

---

## EXPANDED PVC-FREE RANGE

Acrovyn PVC-Free is now available in an updated palette of colours and an extended range of options to provide wall protection solutions fit for any environment.

The offering includes sheet for surface protection and a selection of handrails, crash rails and corner protectors to help you design attractive and effective wall protection schemes for all building areas.

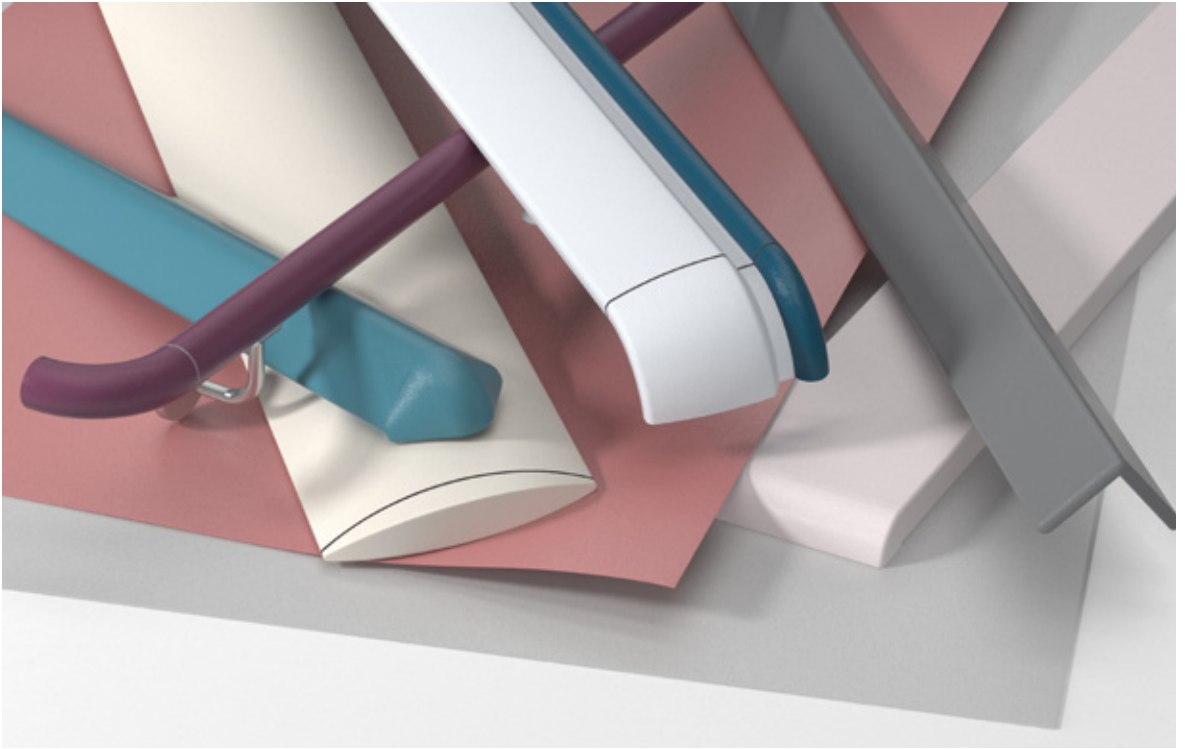

## New Improved Colour Range

Acrovyn PVC-Free Sheet is now available in 36 colours and PVC-Free Profiles in 15 standard solid colours. See our Colour Foldout **pages 150 and 152** for details.



## ACROVYN® BACTERICIDE

In a world where infection control is more important than ever, products which have proven bactericidal efficacy are the ideal solution in healthcare facilities and other areas where hygiene cannot be compromised.

Acrovyn Bactericide pro-actively kills bacteria through surface contact alone, helping to protect patients from Healthcare-Associated Infections (also referred to as nosocomial infections). It has been tested to ISO 22196<sup>1</sup> and proven up to 100% effective against most commonly occurring hospital and food bacteria species.

Sanitized® zinc pyrithione<sup>2</sup>, the

advanced anti-microbial additive incorporated during manufacture of Acrovyn Bactericide products, remains effective throughout their lifecycle and is not affected by most stringent cleaning regimes.

The products are completely safe to humans but deadly for bacteria, guaranteeing long term hygienic conditions.



### CLASSIFICATION OF BACTERICIDE

A plastic surface can only be called bactericide if more than 99% of all bacteria are eliminated. This is determined by the ISO 22196 test and classified according to EN 1040<sup>3</sup> standard.

ISO 22196 determines the bactericidal activity of a plastic surface by applying the following formula:

**Bactericidal activity = log bacteria on control surface - log bacteria on treated surface**

**Bactericide:** when its bactericidal activity is 5 or higher, which translates to 100,000 times fewer bacteria on the treated surface than on the inactive control surface.

**Bacteriostatic:** when its bactericidal activity is between 5 and 1 (100,000 to 10 times fewer bacteria).

**Inactive:** when its bactericidal activity is lower than 1.

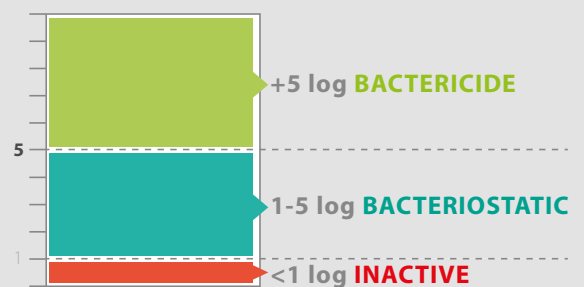

<sup>1</sup> ISO 22196: 2011 'Measurement of antibacterial activity on plastics and other non-porous surfaces'

<sup>2</sup> Sanitized® is a registered trademark of Sanitized AG.

<sup>3</sup> EN 1040: 2005 'Chemical disinfectants and antiseptics - Quantitative suspension test for the evaluation of basic bacterial activity of chemical disinfectants and antiseptics - Test method and requirements (phase 1)'



## TESTED AND CERTIFIED

Acrovyn Bactericide has been tested to ISO 22196 for its bactericidal efficacy against 7 common species and classified under EN 1040.

### Escherichia coli



Activity in log: 5.4  
Class: **Bactericidal**

### Staphylococcus aureus



Activity in log: 5.1  
Class: **Bactericidal**

### Mycobacterium smegmatis



Activity in log: >5  
Class: **Bactericidal**

### MRSA\*

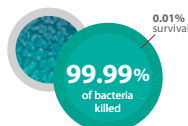

Activity in log: 3.92  
Class: **Bacteriostatic**

### Salmonella enteritidis

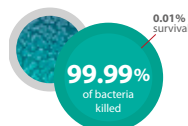

Activity in log: 4.1  
Class: **Bacteriostatic**

### Listeria monocytogenes

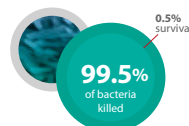

Activity in log: 2.661  
Class: **Bacteriostatic**

### Enterococcus species

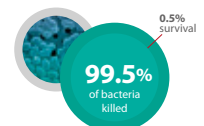

Activity in log: 2.28  
Class: **Bacteriostatic**

\* Methicillin-resistant Staphylococcus aureus

## ACROVYN BACTERICIDE PRODUCT OPTIONS

Acrovyn Bactericide solutions include sheet options for surface protection, handrails and bed head protectors.

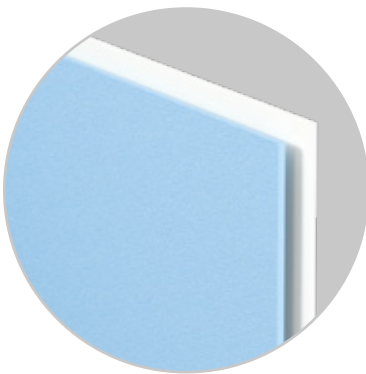

### ACROVYN SHEET

#### Page 42

Available in six colours in Suede texture finish, one colour in Smooth.



### HREB-6 HANDRAIL

#### Page 74

Available in 27 solid colours.



### BL-40V BED HEAD PROTECTORS

#### Page 111

Available in 27 solid colours.

## ACROVYN® SHOWCASE

Acrovyn Showcase is an easy-to-use desktop application that lets you plan and design even complex wall protection concepts in a photorealistic hospital environment. Our newly released version 2020 has been re-written from ground-up with amazing new features to become a comprehensive all-in-one design and planning tool for hospital interiors.

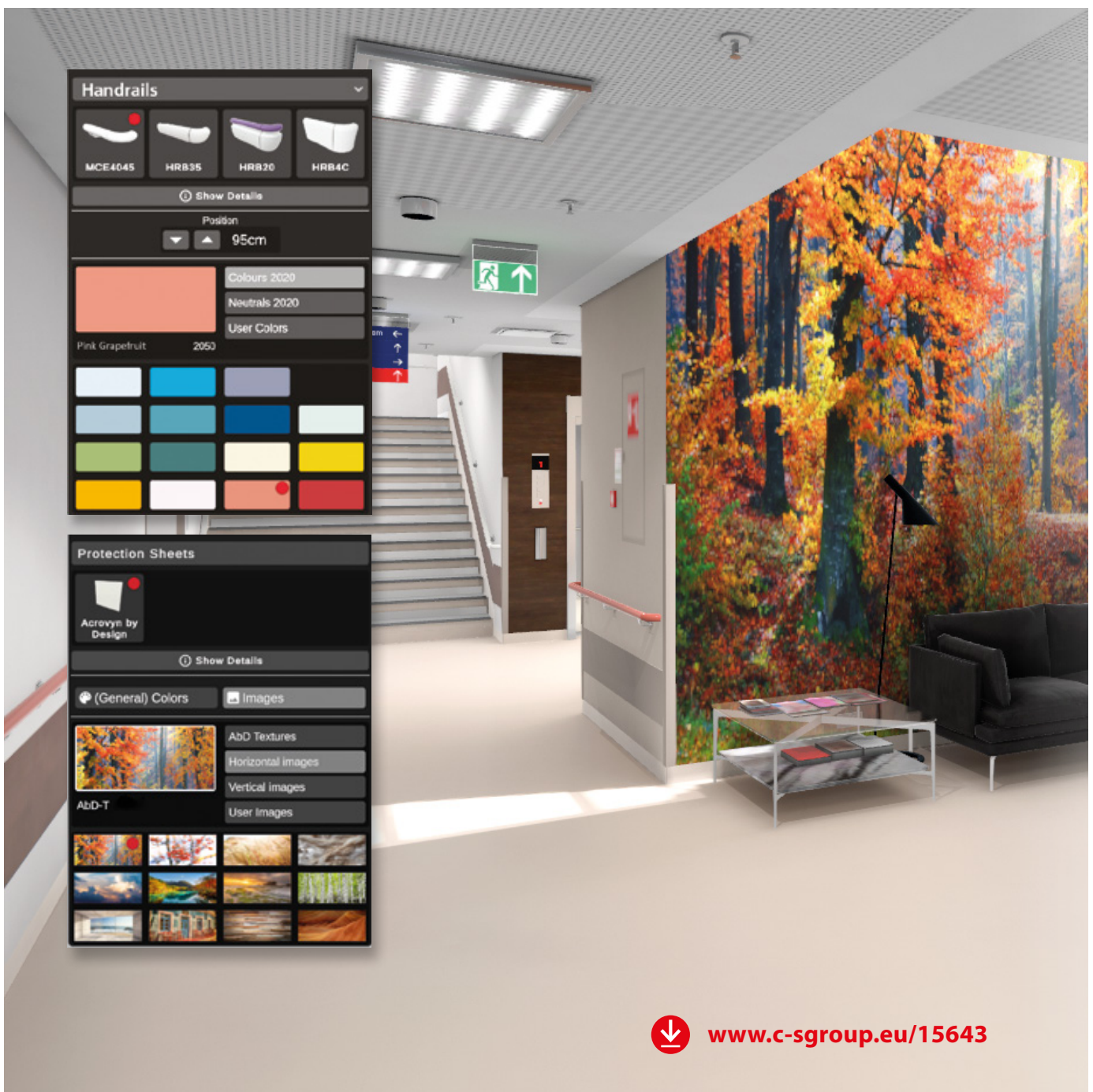

 [www.c-sgroup.eu/15643](http://www.c-sgroup.eu/15643)

## HOSPITAL AREAS

10 hospital areas are available to help you find functional and great looking wall protection concepts.

- 1 Patient room
- 2 Treatment room / Oncology
- 3 Ambulatory surgery
- 4 Hallway / hospital corridor
- 5 Operating theatre
- 6 Scrub room
- 7 Staircase
- 8 Lift area
- 9 Waiting area
- 10 Reception area

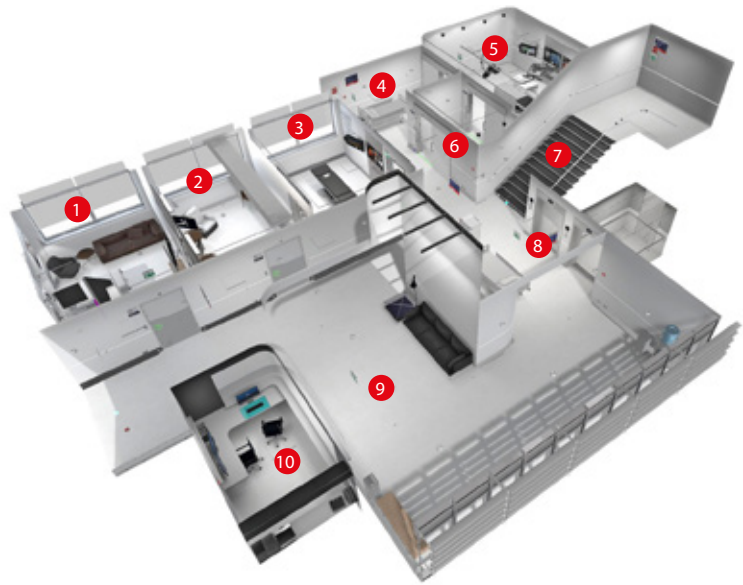

## LATEST FEATURES INCLUDE

### Healing environments

Acrovyn Showcase comes with several interior design pre-sets based on the latest trends in hospital interiors to provide inspiration and a starting point for your bespoke solutions.

### Product Information

Acrovyn products can be inspected in every detail through the built-in Product Inspector. You can also download datasheets, CAD drawings, virtual product samples, BIM Objects and other product related files from within the application.



### New design tools

Acrovyn Showcase lets you design interiors in every detail. All products can be dynamically adjusted in height and wall position. You can specify custom colours for walls, ceiling and floors or load your own images or patterns into Acrovyn by Design murals.

### Collaboration Tools

Save your personal interior designs in Acrovyn Showcase and share them with colleagues or clients. A great feature to gather feedback and plan a hospital interior with others.

To access Acrovyn Showcase app, visit [www.c-sgroup.eu/15643](http://www.c-sgroup.eu/15643)

## A FULLY IMMERSIVE EXPERIENCE

Acrovyn Showcase VR allows you to view and experience your healthcare interiors in every detail and with stunning, lifelike realism. Contact us to arrange a demonstration.



# Designing Effective Wall Protection Schemes

The interior fabric of public, private and commercial buildings is often subjected to extensive wear and tear, or impact damage, compromising aesthetics, hygiene, and affecting maintenance budgets.

Incorporating wall and door protection solutions is a key design factor in these heavy traffic environments, ensuring the longevity and appearance of a building's interior while helping to reduce maintenance costs and the need for repairs and redecorations.

## COMMONLY AFFECTED AREAS:

- Receptions and entrance lobbies
- Corridors and lift areas
- Hospital wards and bedrooms in care homes or hotels
- Commercial kitchens
- Food serving and dining areas
- Manufacturing facilities
- Service areas and back-of-house

## BENEFITS OF USING WALL PROTECTION:

- Increased durability and lifecycle of the building fabric
- Reduced maintenance, repair and refurbishment costs
- Improved aesthetics and unlimited visual freedom
- Compliance with legislation and guidance

### Typical Causes of Damage



Pedestrians



Shopping Carts & Baskets



Chairs



Hospital Beds



Baggage



Catering & Linen Trolleys



Wheelchairs & Pushchairs



Vehicles

 [www.c-sgroup.eu/14233](http://www.c-sgroup.eu/14233)



## TYPES OF WALL PROTECTION:

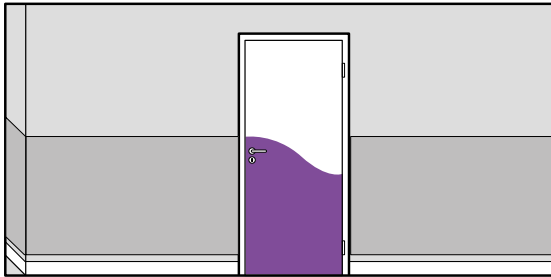

### SURFACE PROTECTION SOLUTIONS

A comprehensive selection of sheets and panels is available for enhancing and protecting walls, columns, reception desks and other interior surfaces from wear and tear or impact damage. See Sheet and Panel Protection section - **page 30**.



### DOOR PROTECTION SOLUTIONS

Acrovyn Door Protection options offer superb impact resistance for vulnerable door faces, edges and frames. Manufactured to bespoke sizes. See Door Protection section - **page 136**.

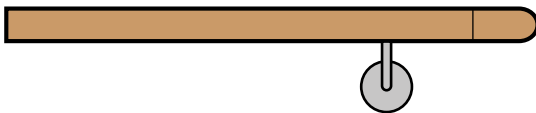

### HANDRAILS

Designed to offer pedestrian support and guidance, Acrovyn handrails combine comfort, style and a degree of surface protection. See Handrail section - **page 70**.



### HAND/CRASH RAILS

Solutions combining handrail and crash rail, designed for areas where both pedestrian support and impact protection is required. See Hand/Crash Rail section - **page 82**.



### CRASH RAILS

For use in circulation areas and service corridors of busy working environments to protect against damage from pedestrian and wheeled traffic. See Crash Rails section - **page 92**.



### CORNER GUARDS

Available in a range of material and size options for the protection of vulnerable external corners. See Corner Guards section - **page 60**.

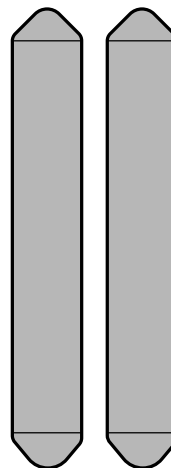

### BED HEAD PROTECTORS

Acrovyn bed head solutions for hospitals and care homes prevent damage to walls and wall-mounted equipment. See Bed Head Protection section - **page 106**.

## WALL PROTECTION SPECIFICATION CONSIDERATIONS

**In order to create interior spaces which are resilient and aesthetically pleasing, due consideration should be given to the environment, the type of activity taking place and the anticipated damage, including its source, frequency and severity, as well as overall interior aesthetics.**

### HANDRAIL PROVISION

In areas where pedestrian access is expected and mobility support may be required handrails should be included.

### INTERIOR SURFACES

Interior surfaces which may be susceptible to damage should be identified (e.g. doors, walls or other surfaces) and most appropriate protection type selected.

### CRASH RAILS

The type and position of crash rails and their duty rating should be related to trolley sizes, anticipated damage position, as well as frequency and severity of impact.

### CORNER GUARDS

The optimum type and height of corner guards should be specified to effectively protect exposed external corners.

### TYPE OF MATERIAL

Which material is best for the location? Acrovyn models are typically used in general circulation spaces, in kitchens there may be preference for stainless steel and in delivery areas for robust EPDM rubber protection.

Depending on the building type, there may be additional considerations, such as ensuring buildings are accessible to all users and other functional requirements are met. We've covered key points which are worth thinking about on the following pages.

## EXAMPLES OF WALL PROTECTION SCHEMES

**Our wall protection range offers solutions to enhance and protect interior décor of all busy environments.**

The following illustrations show examples of wall protection schemes. Other configurations can be easily achieved with our wide portfolio of products.

### LIGHT OR MEDIUM DUTY PROTECTION REQUIREMENTS

For corridors with pedestrian movement and waiting areas with lightweight trolleys in occasional use.

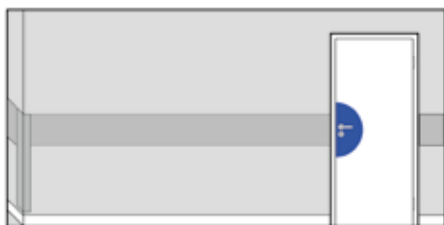

#### Waiting areas

- Corner guards to mid-wall height
- Push rails at mid-wall height
- Push plates on doors



#### Corridors with pedestrian movement and occasional trolleys in use

- Corner guards to mid-wall height
- Handrails at mid-wall height\*
- Push plates on doors

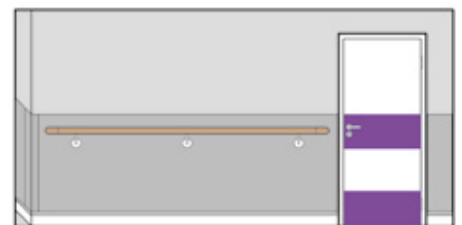

#### Corridors with more frequent trolley movement

- Corner guards to mid-wall height
- Sheet protection to mid-wall height
- Handrails at mid-wall height\*
- Kick plates and push plates on doors

\* For handrail dimensions and position on the wall refer to local legislation.

---

## HEAVY DUTY PROTECTION REQUIREMENTS

For circulation areas susceptible to frequent damage from pedestrian and wheeled traffic such as trolleys, wheelchairs and beds in hospitals.



### Corridors with regular trolley traffic and pedestrian access; impact damage expected at low-wall level

- a. Corner guards to mid-wall height
- b. Handrails at mid-wall height
- c. Crash rails at low level
- d. Kick plates and push plates on doors

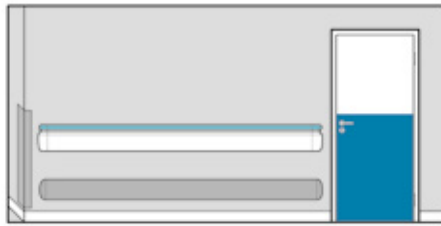

### Corridors with regular trolley traffic and bed movement, where some pedestrian access is still expected

- a. Corner guards to mid-wall height
- b. Hand/crash rails at mid-wall height, crash rail at low wall level
- c. Half face protection to the doors

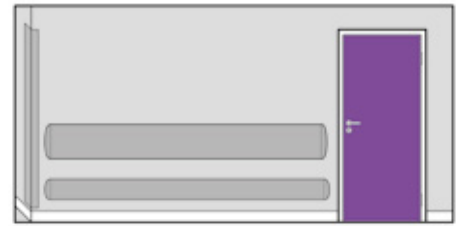

### Corridors with regular trolley traffic and bed movement; impact damage expected at multiple levels

- a. Full height corner guards
- b. Crash rails at two or more levels
- c. Full face door protection

## SEVERE DUTY PROTECTION REQUIREMENTS

For distribution or circulation areas with regular heavily laden trolleys.

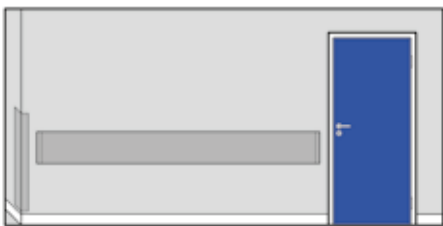

### Corridors with trolley traffic; impact damage expected at mid-wall height

- a. Corner guards to mid-wall height
- b. Crash rail fitted on brackets to keep wheeled traffic away from the wall at mid-wall level
- c. Full face door protection

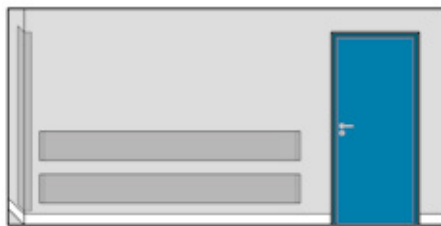

### Corridors with trolley traffic; impact damage expected at multiple levels

- a. Full height corner guards
- b. Crash rails fitted on brackets to keep wheeled traffic away from the wall at two wall levels
- c. Full face door protection and door frame protection



### In delivery areas and some other back of house areas, severe duty EPDM rubber products may be required

- a. Full height corner guards
- b. Severe duty EPDM Rubber crash rails
- c. Full face door protection and door frame protection

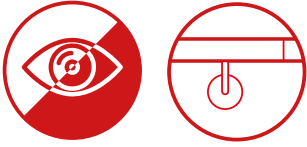

## DESIGNING FOR EVERYONE

Designing new or refurbished building environments so they are accessible and inclusive for all building users requires consideration of the needs of the visually-impaired or those who have physical mobility issues.

### COLOUR CONTRAST AND ACCESSIBILITY

**Most visually-impaired people are able to perceive some light and dark contrasts. To aid their special awareness it is important to use contrasting colours which will help them distinguish between key building elements.**

#### What is Colour Contrast?

Colour contrast is the difference in luminance between two adjacent colours and is determined by the Light Reflectance Value (LRV). This is measured using a sphere-type spectrophotometer to give a value on a scale between 0 and 100.

The value represents a relative lightness and darkness, rather than an actual colour, so totally different colours can have the same, or very similar, LRVs and not be distinguishable by colour blind or visually-impaired people.

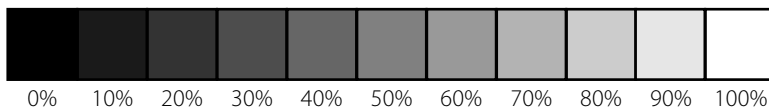

#### Colour Considered Design

What is considered a good colour contrast varies across Europe. In some countries a simple difference in LRV values between two colours is used (e.g. 30 points), in others the contrast is expressed as a percentage (e.g. 70%) and calculated using a formula  $[(\text{Colour 1 LRV} - \text{Colour 2 LRV}) / \text{Colour 2 LRV}] * 100$ .

We therefore recommend checking local guidance or legislation for up to date information to ensure compliance.

Colour contrast should ideally be used wherever surfaces and functions change. In particular large surfaces in a building, as well as key fixtures, fittings and protrusions, should be visually distinguishable from one another, or from the surrounding background. Examples include:

- Door faces and/or door frames to walls
- Floors to walls
- Walls to ceilings
- Obstructions such as corners and pillars
- Handrails to walls
- Sanitary fixings to walls
- Stair treads to risers

#### POOR CONTRAST EXAMPLES:

Lagoon / Coral Blush

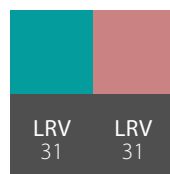

French Cream / Ice Blue

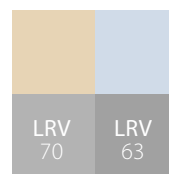

#### GOOD CONTRAST EXAMPLES:

Yale Blue / Snow White

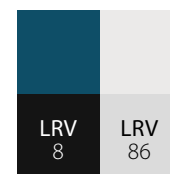

Baltic Blue / Misty Grey

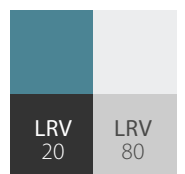

#### Meeting Visual Contrast Requirements with Acrovyn

The Acrovyn Wall Protection range is available in up to 36 colours and several finish options (with a wide spectrum of LRV values), so you can meet visual contrast requirements without having to compromise on design and aesthetics.

Acrovyn sheet, push plates, crash rails or corner guards can be used to highlight obstacles or protrusions. Acrovyn handrails in contrasting colours can be utilised to navigate pedestrians and wheelchair users around obstacles.

For full range of our colours and finishes and their LRV values see the Colour Foldout **pages 150-152**.

## HANDRAIL PROVISION

**The areas of public and commercial buildings which are accessed by the general public may require handrails to be installed to offer support for users with mobility issues.**

This includes staircases, main communication routes within the building or lift areas.

- Handrails should be easy to grasp and provide a firm but comfortable grip with the whole hand.

- They should contrast visually with the wall.
- Their surface should ideally be smooth, free of any abrasive elements, and be neither too cold nor too hot to the touch.
- For handrail dimensions and position on the wall refer to local legislation.

For our selection of ergonomically designed handrails see **page 70**.

*For detailed information and guidance on designing accessible buildings refer to local standards and legislations, including:*

- *Belgium: Guide d'aide à la conception d'un bâtiment accessible (2017); Handboek Toegankelijkheid Publieke Gebouwen (2017)*
- *France: Circulaire interministérielle n° DGUHC 2007-53 du 30 novembre 2007*
- *Germany: DIN 18040-1: 2010-10; DIN 32975: 2009-12*
- *UK: BS 8300-2:2018; Approved Document M, vol. 2 (2015)*
- *International: ISO 21542:2021*



## INFECTION CONTROL & HYGIENE REQUIREMENTS

One of the most significant issues affecting healthcare environments is the control of infection. All finishes used should therefore be chosen with cleanability in mind and be compatible with cleaning agents.

Similarly, food hygiene regulations (e.g. EU Directive No. 852/2004) recommend selection of easily maintainable and durable finishes in food preparation and manufacturing areas.

When specifying wall finishes in hygiene sensitive environments consider the following:

- Smooth, hard, seamless and impervious surfaces are preferred due to their ease of cleaning
- Wall finishes should not promote or sustain the growth of fungi and microorganisms
- They should be durable, able to withstand minor impacts and not be physically affected or degraded by detergents and disinfectant

Interior surfaces should be maintained in sound condition and where appropriate, additional impact protection can be used to help reduce the incidence of damage and maintain the integrity of the walls.



## FIRE REGULATIONS

Compliance with Fire Regulations is one of the most important considerations for any building.

Related legislation varies greatly around the world. As a global building products manufacturer, we have tested our sheet and panel products to harmonised EN 11925-2 and EN 13823 standards to ensure they are safe and compliant across all our European operations.

The results were classified according to EN 13501-1, which ranks construction materials in classes with regard to their fire behaviour: A1, A2, B, C, D, E and F.

The same standard classifies the products with regard to smoke development (s1, s2, s3) and the formation of flaming droplets/particles (d0, d1 and d2).

This ultimately gives a construction material an overall classification that looks something like B-s1, d0.

On each of the product pages, where applicable, we have highlighted the fire ratings of our products to make it easy for you to understand how they perform.

For fire performance information, please get in touch with our technical teams who will be able to assist.

# Spaces worth protecting

## WALL PROTECTION FOR SPECIFIC BUILDING TYPES

Acrovyn wall and door protection products are designed to integrate seamlessly across a wide range of building environments.

Our comprehensive range will meet protection and hygiene requirements of different areas whilst retaining long term aesthetics and helping to reduce maintenance costs.



Healthcare



Care Homes and  
Dementia Care



Retail



Education



Food Retail



Hotels



Offices and  
Workplaces



Sports and  
Leisure



Transport

Visit our website for case studies across market sectors:

 [www.c-sgroup.eu/11674](http://www.c-sgroup.eu/11674)



## HEALTHCARE DESIGNING HEALING INTERIORS

Create calming, therapeutic environments, while maintaining a functional building with resilient and hygienic Acrovyn.

- Introduce artwork and create welcoming, calming interiors with a non-institutional feel, using Acrovyn by Design.
- Wall protection sheet and panels provide a durable hygienic finish and improve aesthetics.
- Create wayfinding schemes and meet visual contrast requirements with our wide range of colours.
- Protect doors and frames from damage caused by trolleys and beds with Acrovyn Sheet
- Provide mobility support with our handrails, available in a wide range of materials including Acrovyn, timber, stainless steel and aluminium, as well as options with bactericide additive.
- A wide array of impact absorbing profiles include rub rails for waiting areas and heavy duty options for busy circulation areas.





## CARE HOMES AND DEMENTIA CARE CREATING A HOMELY AND SAFE ENVIRONMENT

Interior design in care homes should consider the needs of residents, and provide comfortable, safe and easy care accommodation.

- Acrovyn by Design incorporating local scenery creates the feeling of familiarity, and can support wayfinding or reminiscence therapies.
- Sheets in a wide range of solid colours and finishes provide unobtrusive surface protection to walls and doors.
- Our handrails offer support for residents with restricted mobility.
- Areas likely to suffer from impact damage can be effectively protected with corner guards and crash rails.







## RETAIL

# ENHANCING THE CUSTOMER'S EXPERIENCE

Stylish yet functional, Acrovyn impact protection can be incorporated into store design to keep the facility functional and welcoming for customers and staff.

- Acrovyn by Design provides protection to walls and other surfaces as well as brand promotion.
- Impact resistant sheet and corner guards will keep columns and walls in great shape when faced with trolleys, pushchairs and wheelchairs.
- Keep busy doors in functioning order for longer with our range of door protection solutions.
- Use sleek stainless steel products in kitchen and food preparation/service areas.
- Specify heavy duty rubber options for loading bays and car parks.

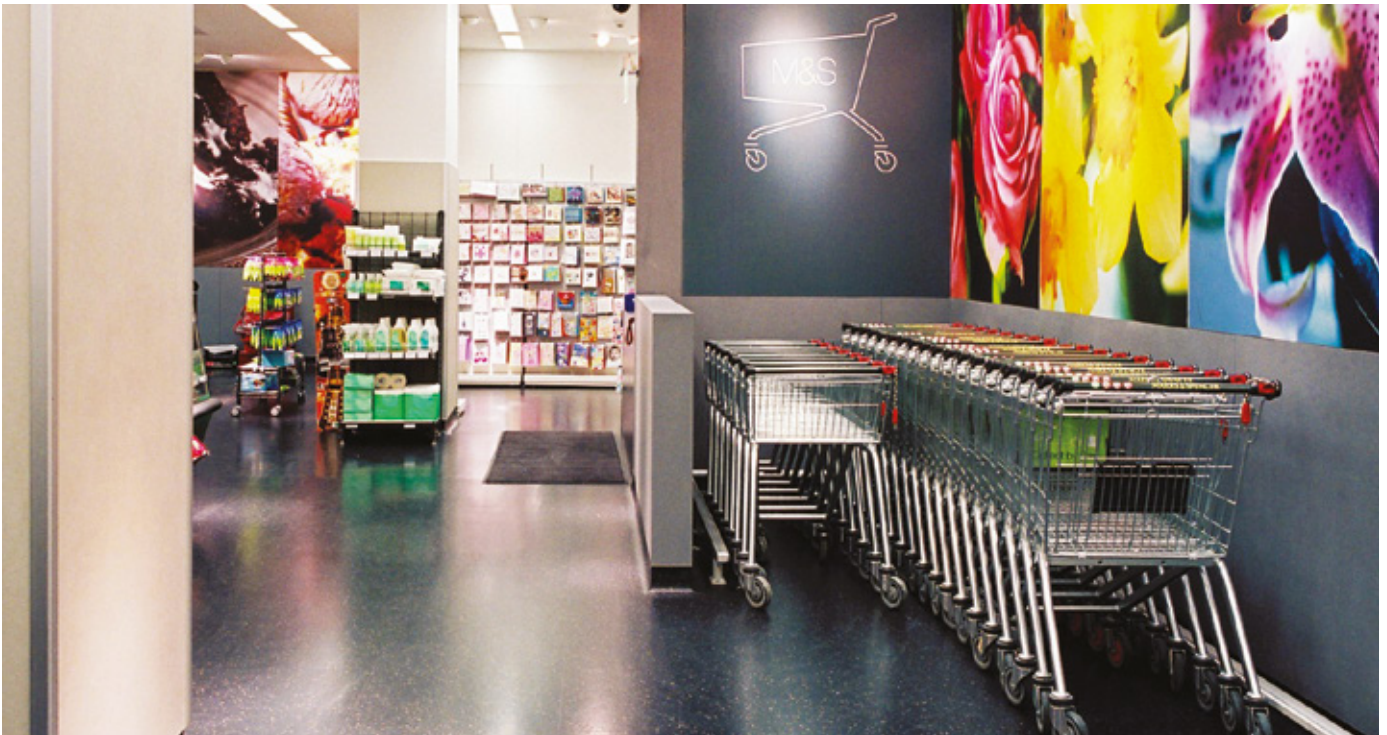



## EDUCATION

### CREATING STIMULATING INTERIORS FOR TOP MARKS



Acrovyn helps to create a clean, bright and stimulating learning environment while protecting the building from the rigours of student life.

- Tough and durable Acrovyn Sheet keeps doors and walls along busy corridors in good condition.
- Incorporate stimulating and inspiring imagery in Acrovyn by Design to positively affect students' performance.
- Coloured corner protection and crash rails help to maintain a functional and inspiring environment for any budget.
- Acrovyn's texture conceals scuffs and general wear & tear caused by bags and everyday use.





## FOOD RETAIL

# DELIVERING THE PERFECT DINING EXPERIENCE



Interior décor sets the right tone and ambience for restaurants and cafés and helps to create a memorable and enjoyable dining experience.

- Use Acrovyn by Design for a unique and lasting interior scheme.
- Acrovyn Sheet protects surfaces from daily wear and tear and can be kept clean easily.
- Smooth sheet and stainless steel wall protection provide hygienic surfaces to kitchen walls and corners.





## HOTELS STAYING IN FIRST CLASS CONDITION



From luxury to budget, hotels are busy venues with luggage and trolley movement throughout the building taking its toll. Decorative and functional Acrovyn helps to keep interiors in top condition.

- Create a welcoming environment with Acrovyn by Design.
- Consider Acrovyn Glass by Design for adding depth and reflection to the interior.
- Use sheet, rub rails and corner guards in corridors, receptions, bedrooms and luggage areas.
- In kitchens and laundry areas, use robust stainless steel corner guards and crash rails.

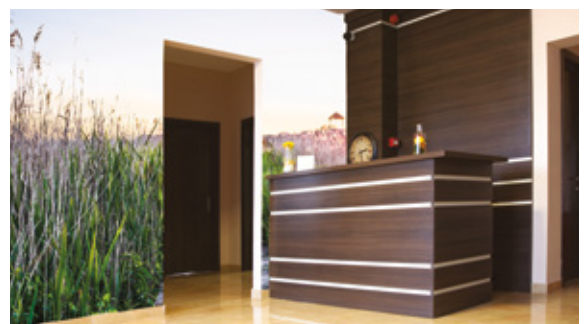



## OFFICES AND WORKPLACES RETAINING A BUILDING'S STYLE

Commercial buildings make a statement through interior design, yet many areas within the building require regular attention to keep them maintained to a high standard.

- Use Acrovyn Sheet and Panels in circulation areas to reduce maintenance.
- Create feature walls with Acrovyn by Design.
- Protect columns and corridor walls with Acrovyn corner guards and crash rails.
- Install rubber or stainless steel profiles to protect back of house areas.





## SPORTS AND LEISURE MAINTAINING INVIGORATING SURROUNDINGS



Sports facilities and fitness centres are busy, energetic environments. Acrovyn will keep the facility in excellent condition for years.

- Use sheet, corner guards and crash rails in corridors, equipment rooms and changing rooms.
- Use Acrovyn by Design to reinforce branding and create energising and stimulating surroundings.
- Acrovyn handrails provide support where required.
- Protect back of house areas and car parks with robust rubber products.



## TRANSPORT DELIVERING DURABLE PROTECTION

With high levels of pedestrian and vehicular traffic passing through busy airports and other transport interchanges impact damage is inevitable.

- Use Acrovyn crash rails, corner guards and sheet to protect check-in desks, arrival lounges, waiting areas and retail areas from damage.
- Use durable Acrovyn by Design in retail and passenger transfer areas.
- Heavy duty rubber protection will stand up to the rigours of back of house corridors, baggage handling areas and underground car parks.



# Acrovyn® Sheet & Panels

The Acrovyn range provides designers and facility owners with attractive, durable and easy to maintain surface protection solutions.

Choose from tried and tested textured sheets designed to keep interiors looking good for years, or select one of our specialist solutions for areas with increased hygiene or fire performance requirements.

For unlimited visual freedom when creating beautiful spaces, specify bespoke Acrovyn by Design.

Acrovyn gives you all the tools you need to design stunning interiors that last.

 [www.c-sgroup.eu/413](http://www.c-sgroup.eu/413)

## APPLICATIONS:

- Walls, reception desks, columns and other interior surfaces which need a protective and durable finish
- All market sectors from healthcare and education, to commercial and transport



**ACROVYN SHEET -  
DECORATIVE FINISHES**

**ACROVYN  
BY DESIGN**

## DESIGN CHOICES

Discover the versatility of our range and be creative with your next wall protection scheme.

Find perfect harmonies of colours and finishes, introduce bespoke artwork, shapes and designs, mix and match materials - it's all possible with Acrovyn.



## SOLID COLOURS

A refreshed palette of up to 36 solid colours is at your disposal to beautifully integrate wall protection with other interior decor elements.



Most of our impact-resistant options share the same light, Suede texture, helping to conceal scratches and abrasions while facilitating easy cleaning. For ultra-hygienic environments opt for our smooth solutions.





**ACROVYN DOOR PROTECTION**

**ACROVYN SHEET OR PANELS**



### BESPOKE DESIGNS

To add personality and expression to your spaces select Acrovyn by Design. Any patterns, bespoke colours, graphics, messages or imagery of your choice will be safely embedded behind a protective layer of our sheet.

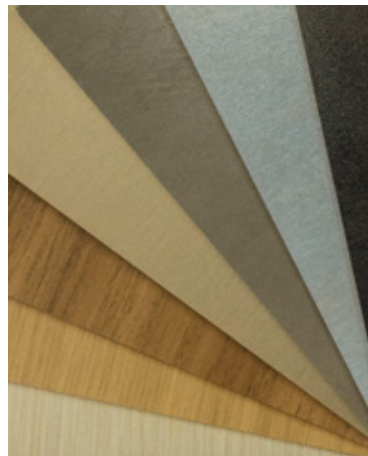

### DECORATIVE FINISHES

Add warmth to any interior with attractive woodgrains, update a classic look with the glow of metallics or create a contemporary effect with new concrete patterns.



# The Range

## Acrovyn Textured Sheet - Solid Colours



● Acrovyn

**Colours:** 36 solid  
**Thickness:** 2mm or 1mm  
**Page 34**

## Acrovyn by Design



● Acrovyn PVC-Free

**Colours:** Bespoke design  
**Thickness:** 1.5mm  
**Page 50**

## Acrovyn Textured Sheet - Decorative Finishes

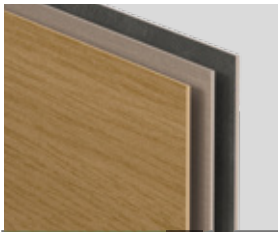

● Acrovyn

**Colours:** 12 finishes  
**Thickness:** 2mm  
**Page 36**

## Acrovyn Glass by Design



● Safety Glass

**Colours:** Clear, painted or printed  
**Thickness:** 6mm  
**Page 54**

## Acrovyn PVC-Free Textured Sheet

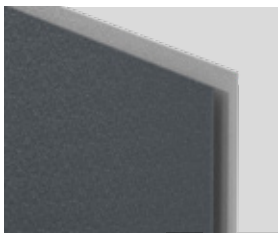

● Acrovyn PVC-Free

**Colours:** 36 solid  
**Thicknesses:** 1.5mm or 1mm  
**Page 38**

## Acrovyn Wall Panels



● Acrovyn ● Acrovyn PVC-Free

**Colours:** Up to 36 solid  
**Thickness:** Varies  
**Page 56**

## Acrovyn Smooth Sheet



● Acrovyn

**Colours:** 10 solid  
**Thickness:** 2mm  
**Page 40**

## Acrovyn FP Panels



● Coated Gypsum Fibre Board

**Colours:** 36 solid Acrovyn or RAL  
**Thickness:** 12.5mm  
**Page 58**

## Acrovyn Bactericide Sheet



● Acrovyn Bactericide

**Colours:** Suede - 6 solid, Smooth - 1 solid  
**Thickness:** 2mm  
**Page 42**

## Acrovyn Stainless Steel Sheet



● Stainless Steel

**Finish:** Brushed  
**Thickness:** 1mm  
**Page 44**

## Sheet Finishing Accessories and Tools



Overview of available finishing accessories (trims, mastic, welding), adhesives and installation tools  
**Page 46-47**

 [www.c-sgroup.eu/413](http://www.c-sgroup.eu/413)

# Acrovyn® Textured Sheet

## SOLID COLOURS

Acrovyn Sheet provides an attractive and highly durable surface finish for a variety of situations.



CE Marked



B-s2, d0



Class A+

Designed to protect and enhance building interiors, our impact-resistant sheet features a light textured finish to conceal scratches and abrasions. It can be easily maintained to a high standard to provide long lasting protection for surfaces it is applied to.

Now available in an updated range of colours and contemporary texture to beautifully integrate into interior design schemes.

### APPLICATIONS:

- Walls in corridors, entrances or waiting areas and other spaces requiring a durable wall finish
- Reception desks
- Columns

 [www.c-sgroup.eu/414](http://www.c-sgroup.eu/414)

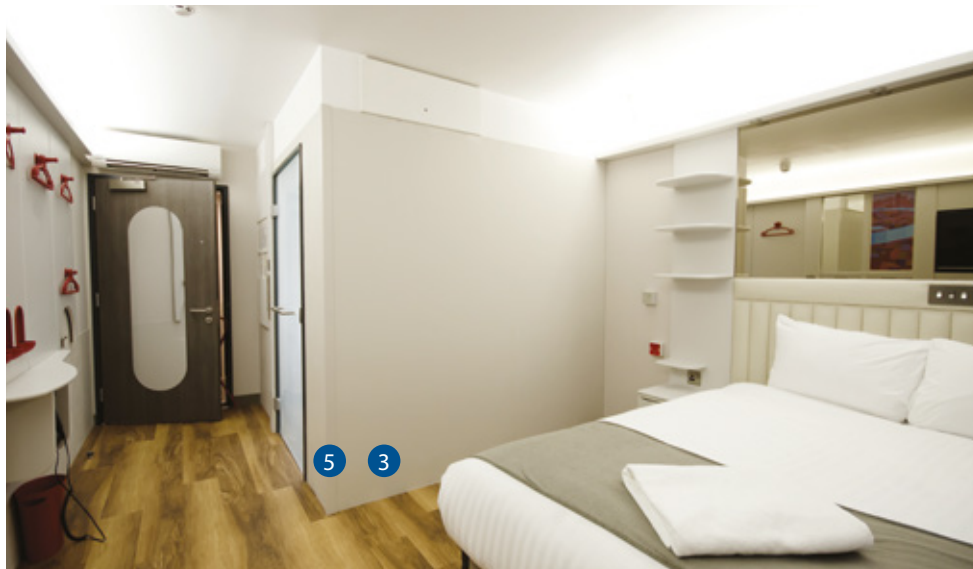

### KEY FEATURES

- Impact, scratch and abrasion resistant
- Easy to cut, form and apply to a variety of substrates
- Two thicknesses available to suit protection requirements
- Through-coloured and textured to hide scratches and abrasions
- Impervious and non-porous surface, resistant to most stains or chemicals
- Easy to clean and maintain



- 1 Acrobyn Push Plate  
**Page 142**
- 2 Acrobyn Kick Plate  
**Page 142**
- 3 2mm Acrobyn Textured Sheet
- 4 Acrobyn SO-50V Corner Guard  
**Page 67**
- 5 Acrobyn 1mm Sheet
- 6 Acrobyn SO-50 Corner Guard  
**Page 67**

## DESIGN OPTIONS

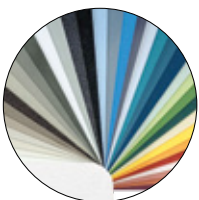

### The range

Choose from our updated colour range of 36 solid shades. See Colour Foldout **page 150**

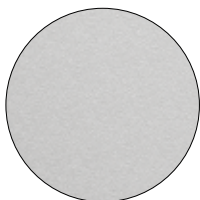

### Suede texture

New, lighter texture gives the material a contemporary appearance, fit for any type of interior.



### Shapes

Creative designs, signage and logos can be supplied. See **page 48** for further information.



## PRODUCT SPECIFICATION

### Thickness and size

2mm thick: 3000mm x 1300mm\* or 2440mm x 1300mm\*  
\* Custom sizes within given dimensions available.

### Finishing options

A range of options available, see details on **page 46**.

# Acrovyn® Textured Sheet

## DECORATIVE FINISHES

Our range of wood, metal and concrete finishes combines the warmth and contemporary looks with durability of Acrovyn.



Class M1



Class A+

Add a decorative and protective finish to your building surfaces with our new finishes selection.

Bring depth and a calming sense of nature to the interior with natural looking woodgrains, a feel of luxury with our new metallic options, or create a striking, contemporary effect with brand new concrete patterns.

Our long lasting, easy to install and maintain finishes will enhance any interior space.

### APPLICATIONS:

- Walls in corridors, entrances, waiting areas and other spaces requiring a durable wall finish
- Reception desks
- Columns

 [www.c-sgroup.eu/16723](http://www.c-sgroup.eu/16723)



- 1 2mm Acrovyn Textured Sheet, woodgrain finish
  - 2 2mm Acrovyn Textured Sheet, concrete finish
  - 3 Acrovyn SO-50 Corner Guard, concrete finish
- Page 67**



### KEY FEATURES

- Impact, scratch and abrasion resistant
- Easy to cut, form and apply to a variety of substrates
- Impervious and non-porous surface, resistant to most stains or chemicals
- Easy to clean and maintain



## DESIGN OPTIONS

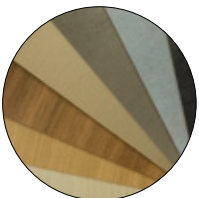

### The range

Choose from our updated range of woodgrain, metal and concrete finishes. See Colour Foldout **page 151**.

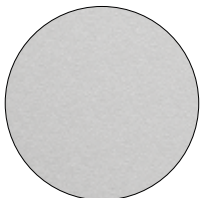

### Suede texture

New, lighter texture gives the material a natural, contemporary appearance, fit for any type of interior.



### Shapes

Creative designs, signage and logos can be supplied. See **page 48** for further information.



## PRODUCT SPECIFICATION

### Thickness and size

2mm thick: 3000mm x 1250mm\*

\* Custom sizes within given dimensions available.

### Finishing options

A range of options available, see details on **page 46**.

# Acrovyn® PVC-Free Textured Sheet

Our most environmentally friendly surface protection is designed to maximise the lifecycle of interior surfaces, while protecting the environment.

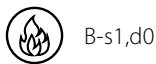

The material is free from PVC, Persistent Bioaccumulative Toxins (PBTs), Bisphenol A (BPA), as well as halogenated or brominated fire retardants.

Recently assessed under the globally recognised Cradle to Cradle Certified™ Products Program, Acrovyn PVC-Free achieved Bronze certification, giving you confidence to specify it in green building schemes.



## APPLICATIONS:

- Walls in corridors, entrances or waiting areas and other areas requiring a durable wall finish
- Reception desks
- Columns



 [www.c-sgroup.eu/8138](http://www.c-sgroup.eu/8138)



## KEY FEATURES

- Impact, scratch and abrasion resistant
- Easy to cut, form and apply to a variety of substrates
- Two thicknesses available to suit protection requirements
- Through-coloured and textured to hide scratches and abrasions
- Impervious and non-porous surface, resistant to most stains or chemicals
- Easy to clean and maintain





- 1 1.5mm Acrovyn PVC-Free Textured Sheet
- 2 Acrovyn SM-20N Corner Guards **Page 64**

## DESIGN OPTIONS

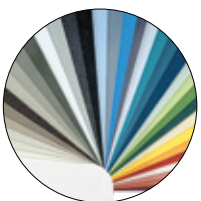

### The range

Choose from our updated colour range of 36 solid shades. See Colour Foldout **page 150**

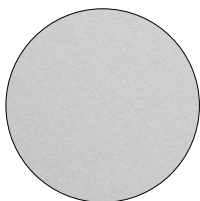

### Suede texture

Our light texture gives the material a contemporary appearance, fit for any type of interior.



### Shapes

Creative designs, signage and logos can be supplied. See **page 48** for inspiration and further information.



## PRODUCT SPECIFICATION

### Thickness and size

1.5mm thick: 3000mm x 1300mm\*

1mm thick: 3000mm x 1300mm\*

\* Custom sizes within given dimensions available.

### Finishing options

A range of options available, see details on **page 46**.

# Acrovyn® Smooth Sheet

Acrovyn Smooth Sheet provides an easy to clean, durable surface for sterile environments.



It is recommended for hygiene sensitive areas requiring a smooth, impervious surface, which won't crack under impact and become a breeding ground for bacteria.

The material is resistant to a wide range of chemicals making it suitable for a variety of applications.

Easy to clean surface conforms to EU food hygiene requirements. It is also suitable for steam cleaning to suit stringent cleaning regimes.

## APPLICATIONS:

- Laboratories
- Kitchens
- Food serving and dining areas
- Food manufacturing
- An alternative to tiles



Now available in an extended and updated range of colours with matching accessories. See Colour Foldout **page 150**.



- 1 Full height Acrovyn Smooth Sheet
- 2 Acrovyn Sheet Door Protection **Page 140**
- 3 LLRSS Stainless Steel Rail **Page 122**
- 4 Welded joints for maximum hygiene



## KEY FEATURES

- Smooth, impervious and non-porous surface
- Easy to clean and maintain to a high standard. Suitable for hot steam cleaning
- Resistant to most stains and chemicals
- Easy to cut, form and apply to a variety of substrates



### STEAM CLEANING

Acrovyn Smooth Sheet has been tested and certified to be suitable for hot steam cleaning (150°C hot steam at 5 bar pressure), making it an ideal solution for areas where stringent cleaning takes place.



### CHEMICAL RESISTANCE

Resistant to a wide range of chemicals, including commonly used acids, alkalis, alcohols, grease etc. to suit a wide range of environments. Chemical resistance data available on request.



### PRODUCT SPECIFICATION

#### Thickness and size

2mm thick: 3000mm x 1300mm\*

\* Custom sizes within given dimensions available.

#### Finishing options

A range of options is available, including trims, mastic and hot welding. See details on **page 46**.



[www.c-sgroup.eu/415](http://www.c-sgroup.eu/415)

# Acrovyn® Bactericide Sheet

Developed to help combat the threat of hospital acquired infections (HAI), our solution is proven to kill bacteria on contact.



CE Marked



B-s2,d0



Class A+

Acrovyn Bactericide Sheet has been third party tested to ISO 22196 and proven effective against seven most common hospital and food bacteria species.

Available in textured and smooth variants, it provides a highly resilient, bacteria-free surface finish in areas where hygiene cannot be compromised.

Where pedestrian access is expected complementary smooth HREB-6 Handrails with bactericide can be specified. See **page 74**.

## APPLICATIONS:

- Operating theatres
- Post-operating and dialysis areas
- Laboratories
- Kitchens
- Food serving and dining areas
- Food manufacturing

 [www.c-sgroup.eu/7300](http://www.c-sgroup.eu/7300)



- 1 Full height smooth Acrovyn Bactericide Sheet
- 2 Textured Acrovyn Bactericide Sheet as door protection



**TESTED AND CERTIFIED**

Acrovyn Bactericide has been tested to ISO norm 22196 for its bactericidal efficacy against seven common species.

Classified under EN 1040. For further details see **page 10**.

\*Methicillin-resistant *Staphylococcus aureus*

### Escherichia coli



Activity in log: 5.4  
Class: Bactericidal

### Staphylococcus aureus



Activity in log: 5.1  
Class: Bactericidal

### Mycobacterium smegmatis



Activity in log: >5  
Class: Bactericidal

### MRSA\*

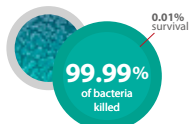

Activity in log: 3.92  
Class: Bacteriostatic

### Salmonella enteritidis

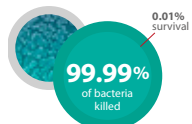

Activity in log: 4.1  
Class: Bacteriostatic

### Listeria monocytogenes



Activity in log: 2.661  
Class: Bacteriostatic

### Enterococcus species



Activity in log: 2.28  
Class: Bacteriostatic



## KEY FEATURES

- Choice of textured or smooth finish
- Through-coloured, impervious and non-porous material
- Resistant to most stains and chemicals
- Easy to clean and maintain to a high standard. Suitable for hot steam cleaning
- Easy to cut, form and apply to a variety of substrates



## COLOURS AND TEXTURES

Available in Suede texture (6 colours) or Smooth (9003 Snow White). See Colour Foldout **page 150**.

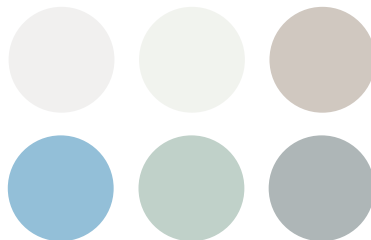

## PRODUCT SPECIFICATION

### Thickness and size

2mm thick: 3000mm x 1300mm\*

\* Custom sizes within given dimensions available.

### Finishing options

A range of options is available, including trims, mastic and hot welding. For further information see **page 46**.

# Acrovyn® Stainless Steel Sheet

Durable, versatile sheet protection for hygiene sensitive and commercial applications.

After decades of use in commercial environments, stainless steel continues to be the wall protection solution of choice for its cool elegance, heavy duty resistance and superb hygienic properties.

Our stainless steel sheets are manufactured from Grade 304L stainless steel, with an attractive brushed finish.

For complementary range of stainless steel Corner Guards and Crash Rails see **pages 120-124**.

## APPLICATIONS:

- Kitchens
- Food serving areas
- Dining areas
- Food manufacturing
- Laboratories

 [www.c-sgroup.eu/16637](http://www.c-sgroup.eu/16637)

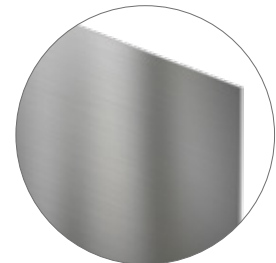

## MATERIAL AND FINISH

Manufactured from Grade 304L stainless steel, our sheet has an attractive, easy to clean and maintain brushed finish.



## PRECISION CUTTING

Stainless steel sheets can be cut to custom specifications. Whether you ask for a straight edge, wave pattern or other edge shape, we can deliver a perfect cut thanks to the precision of our high pressure water jet cutting equipment.



## PRODUCT SPECIFICATION

### Thickness and size

1mm thick: 2500mm x 1250mm\*

\* Custom sizes within given dimensions available.

### Installation

Installation using construction adhesive. Sheets are installed butt-jointed. Custom formed angles or channels available.

# Acrovyn® Sheet

## FINISHING ACCESSORIES

Like most materials, Acrovyn Sheets will expand and contract with changes in temperature. If temperature fluctuations are to be expected, it is important to allow for this at sheet edges, in joint positions and around cut outs during installation. A range of finishing options is available.

### Mastic Joints

Mastic sealant is easy to apply and forms an impervious seal. Available in 36 solid colours. Additional colours complementing Decorative Finishes also available. Supplied in 310ml tubes.



### Hot Welded Joints

Welded joints creating a durable and seamless finish can be achieved with solid colour 2mm and 1.5mm sheet options. Rods available in 36 solid colours, in rolls of 100m.



### Trims

For use with all sheet thicknesses, supplied in 3m lengths.

#### Acrovyn trims:

- Edge trim for finishing part height wall applications.
- Vertical Trim - 2-part design for ease of installation.

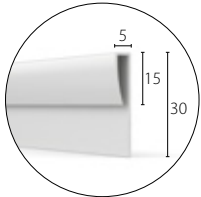

36 colours

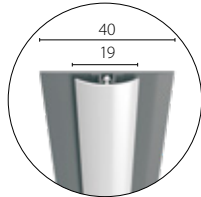

36 colours (front)

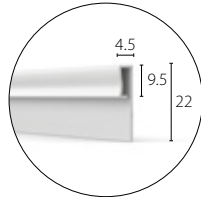

6 colours\*

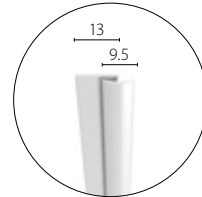

6 colours\*

\* More colours available, subject to extended lead time

#### Aluminium trim:

- Edge trim for finishing part height wall applications.

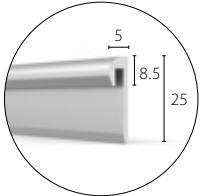

Natural anodised

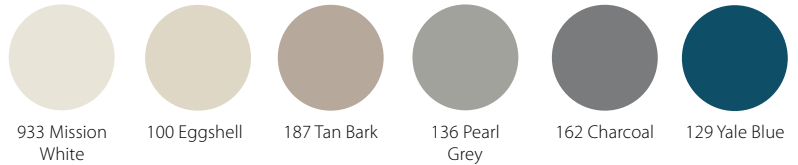

## CUTTING, FORMING & FINISHING

### Cutting and Design Shapes

Acrovyn Sheets can be pre-cut to project specific sizes. Custom shapes and signage can also be produced - see **page 48**.

### Edge Beveling

Straight cut edge is standard, 45° or round bevel can be supplied on request.

### Acrovyn Plinth

2mm plinth with a round bevel on the top and a flexible bottom lip. Available in 27 Acrovyn Profile colours, see **page 152**.

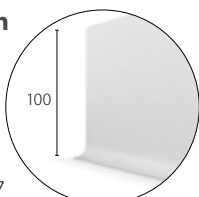

PLINTH

### Forming

All Acrovyn Sheets can be formed on site into angles or channels to fit around external or internal corners, columns or skirting boards. Pre-formed sections can be supplied to order.

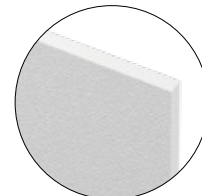

45° EDGE BEVEL

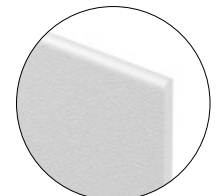

ROUND BEVEL

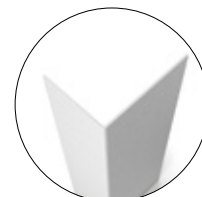

ANGLES  
from 45° to 150°



CHANNELS  
2 folds



## COMPLEMENTARY PRODUCTS

Corner guards and rub rails are often specified with Acrovyn Sheet applications. A range of options is available to suit:

### SM-20 / SSM-20

- Acrovyn
- Acrovyn PVC-Free

**Leg:** 76mm / 51mm  
**Angles:** 90°  
**Duty Rating:** Heavy  
**Pages 64 / 65**

### SO / SO-50V

- Acrovyn

**Leg:** 30, 50, 75mm  
**Angles:** 90° / 80°-175°  
**Duty Rating:** Medium  
**Page 67**

### TF-N

- Acrovyn PVC-Free

**Leg:** Made to order  
**Angles:** 90°  
**Duty Rating:** Medium  
**Page 68**

### Stainless Steel

**Leg:** 30, 50, 75mm  
**Angles:** 90° & custom  
**Duty Rating:** Heavy  
**Page 124**

### TP Rub Rail

- Acrovyn

**Height:** 100, 150, 200, 300mm  
**Duty Rating:** Medium  
**Page 104**

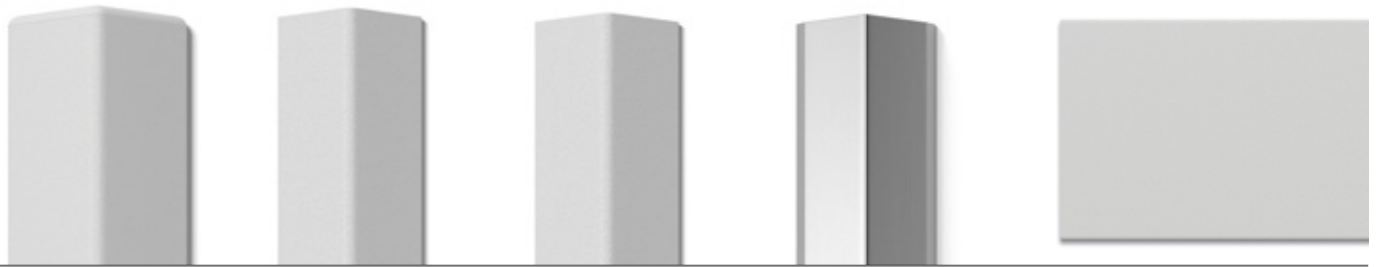

## INSTALLATION TOOLS AND ACCESSORIES

We offer a range of adhesives, tools and installation accessories to aid application of our sheet products.

### Adhesives



Adhesives to suit different application conditions and requirements:

- Acrovyn and Acrovyn PVC-Free Sheet application adhesives, available in tubs, foil packs or cartridges to suit
- Adhesive for application in moist areas
- Sprayable adhesive, complete with spray hose and gun
- Contact adhesive tape (50m rolls)
- Primer for substrate preparation

### Tools and equipment



- Crane rollers
- Deburring tools
- Craft knives
- Welding kits
- Battery powered silicone guns
- Adhesive applicator trowels
- Spray guns & hoses
- Cleaners

Product availability may vary locally. For full details contact your local office or visit [www.c-sgroup.eu/16724](http://www.c-sgroup.eu/16724)

# Acrovyn® Sheet

## DESIGNS AND CUTTING

Wall protection is no longer just a functional part of the built environment. A wide selection of colours, finishes and styles allows you to create interior spaces which are both resilient and aesthetically pleasing.

Acrovyn Sheet is a versatile material, which is easy to cut, shape and form to help you realise your design vision. Imaginative, bright wall murals, durable signage and logos, or decorative door protection plates can be easily achieved.

For true design freedom consider Acrovyn by Design, allowing you to incorporate nearly any image or message into walls for a completely unique creation. Turn to **page 50** for more information.



 [www.c-sgroup.eu/17146](http://www.c-sgroup.eu/17146)

### YOUR DESIGNS REALISED

Our advanced CNC cutting equipment allows us to produce your designs with ease and precision. All we need is your designs in .dxf format, we'll take care of the rest.

If you need help with creating custom designs please get in touch. We have a library of shapes and patterns that may be suitable, or will work with you to create something bespoke.

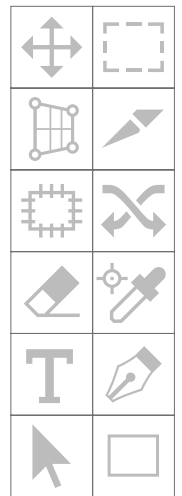

### STANDARD DESIGN

Wave design has been the most frequently requested pattern, so to make it easy for you, we've made it our standard option.

All you need to do is specify Acrovyn material and colour you want it produced in.

### WAVE

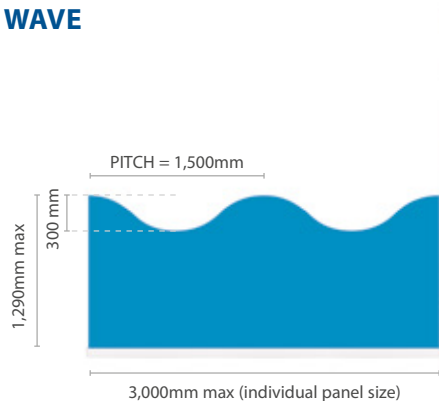

### CUSTOM

We can produce your custom designs, simply supply them to us in .dxf format.

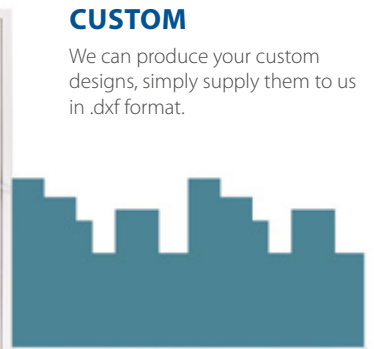



# Acrovyn by Design®

It has been proven that imagery used in interior design can have a positive impact on learning, healing, productivity and general wellbeing of building occupants.

Acrovyn by Design offers architects, interior designers, and owners the ability to create stunning interiors without the worry of damage.

Large format custom graphics, photography, and messaging can be safely embedded behind durable, transparent Acrovyn PVC-Free Sheet.

## APPLICATIONS:

- Entrance lobbies and reception areas in all types of buildings
- Corridors
- Wayfinding
- Hospital wards
- Hotel bedrooms
- Classrooms
- Sports venues and fitness centres

 [www.c-sgroup.eu/2636](http://www.c-sgroup.eu/2636)



## IMAGES

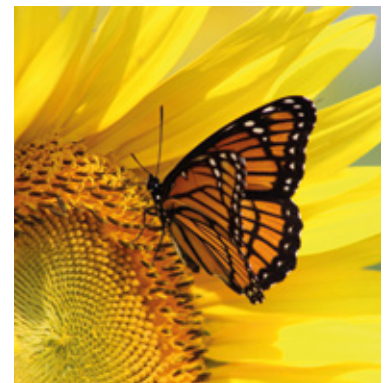



## PATTERNS

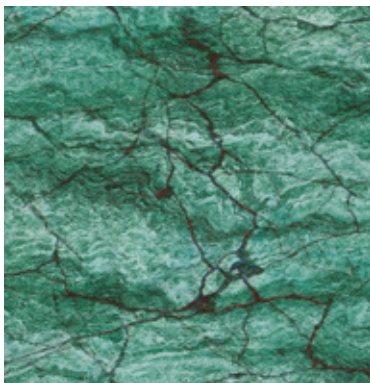

## GRAPHICS

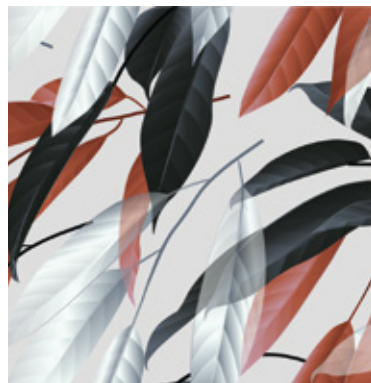

## LOGOS AND MESSAGING



Your artwork reverse printed behind clear Acrovyn PVC-Free Sheet stays protected from wear and tear or damage.

# Acrovyn by Design®

## COMPOSITION

Acrovyn by Design features high-resolution print on the reverse of clear, lightly textured Acrovyn PVC-Free Sheet.

The sheet serves as a protective shield for the imagery and provides an impact resistant, easily cleanable surface.

Acrovyn PVC-Free Sheet is free from BPA (Bisphenol A), PBTs (Persistent Bioaccumulative Toxins) and halogenated or brominated fire retardants, making it better for building occupants and the environment.

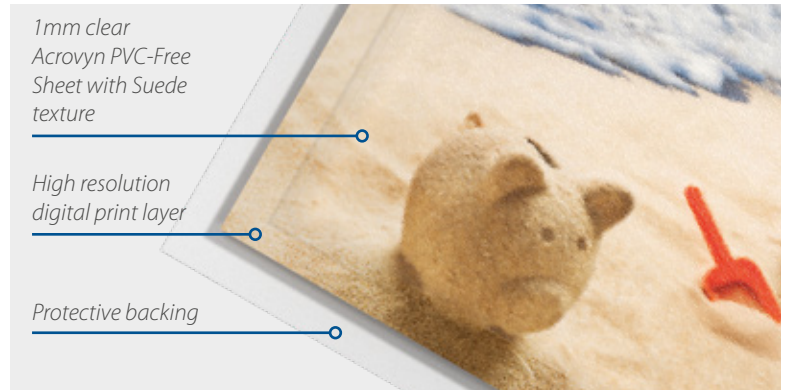

## SIZES

Acrovyn by Design is produced in sizes to suit your project requirements. Maximum individual sheet size is **3020mm x 1270mm**.

Large wall murals will comprise of multiple sheets, which will be cut as necessary with no additional cutting charge.

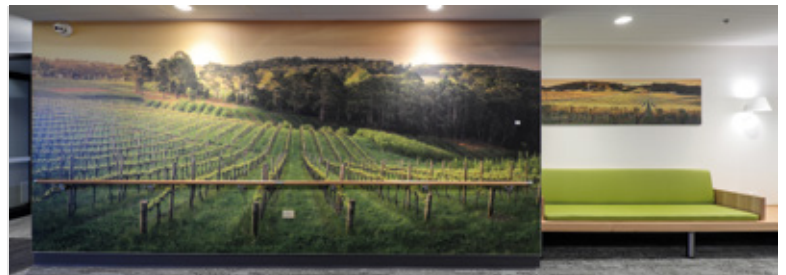

## CHOOSING YOUR IMAGE

### IMAGE TYPE AND QUALITY

To ensure best results check the quality of your image at the actual print size before ordering. This is particularly important for bitmap images as they can lose quality if resized too much. Vector artwork will produce crisp results at any output size.

The acceptable resolution for your project will depend on how the viewer will be interacting with the image. Based on the amount of information the human visual system can perceive and process, images seen from a longer distance can be output at a lower resolution.

For further guidance and a handy on-line image resolution check tool visit [www.c-sgroup.eu/2636](http://www.c-sgroup.eu/2636)

Vector images (.ai, .eps or .wfm) are infinitely scalable, so you can be sure of high quality print at any size.



Bitmap images (.jpg, .tif, .psd, or RAW) can lose quality if resized too much.

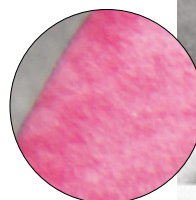

## CHOOSING YOUR IMAGE (CONT).

### CUSTOM COLOURS

Acrovyn by Design can be printed with a solid colour. However, due to the print process limitations, it is not always possible to exactly match Pantone colours. If colour matching is critical, samples will be provided for proofing before we print.



### NEED AN IMAGE?

Image banks, such as Shutterstock, iStock or Adobe Stock Image offer a huge selection of images that you may want to consider for your project. Please check that the image size is sufficient for your Acrovyn by Design mural before sourcing.



### COPYRIGHT

We respect the intellectual property rights of others and will only print your image if you can provide evidence that you have the right to reproduce it. We will require a signed Copyright Agreement before we proceed with print.



## ORDERING ACROVYN BY DESIGN



### PRICING

We will require a basic design of the wall area with relevant dimensions to provide you with an accurate indication of cost.



### ARTWORK

We are here to answer your artwork queries and can assess suitability of your files for printing.

If you don't have the artwork but still want to benefit from Acrovyn by Design get in touch, we may be able to assist you with buying a stock image.



### LAYOUTS

To start preparing your artwork to print we will need accurate wall elevation drawings indicating image cut areas.

This will enable us to layout your artwork over optimum number of sheets to ensure a perfect fit to your wall.

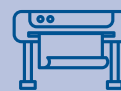

### PRINTING

We will submit job layouts for your approval and once you are happy with everything we start printing process.

Our high-resolution, large format printing hardware and colour management software ensure a perfect result.



### INSTALLATION

Panels are quality checked before being sent to you ready for installation with the adhesive solution of your choice.

## FINISHING ACCESSORIES

In temperature controlled environments, or areas where fluctuations are minimal, sheets can be butt jointed.

In locations where temperature will vary, we recommend a small gap is left between sheets to allow for expansion and contraction of material.

The following finishing options are available:

### Mastic joints

Mastic sealant is an easy to apply solution, forming an impervious seal.

Available in 36 standard colours and in clear.

### Trims

**Acrovyn trims:** Edge trim and vertical trim are available in 36 solid colours.

**Aluminium trims:** Edge trim in natural anodised finish.

See **page 46** for details

# Acrovyn® Glass by Design

Manufactured from toughened safety glass and available in custom options, our panels are designed to protect your walls in style.



A1 Fire Rated

Our durable glass panels combine high quality with functionality and aesthetic appeal.

Clear option allows for the original wall finish to be displayed behind a protective layer of 6mm thick toughened safety glass.

Where a bespoke look is desired, panels can be back-painted in any of RAL or NCS solid colours, or back-printed with an image or graphic of your choice for a truly stunning effect.

## APPLICATIONS:

- Corridors
- Entrances and waiting areas
- Kitchens
- Shower enclosures

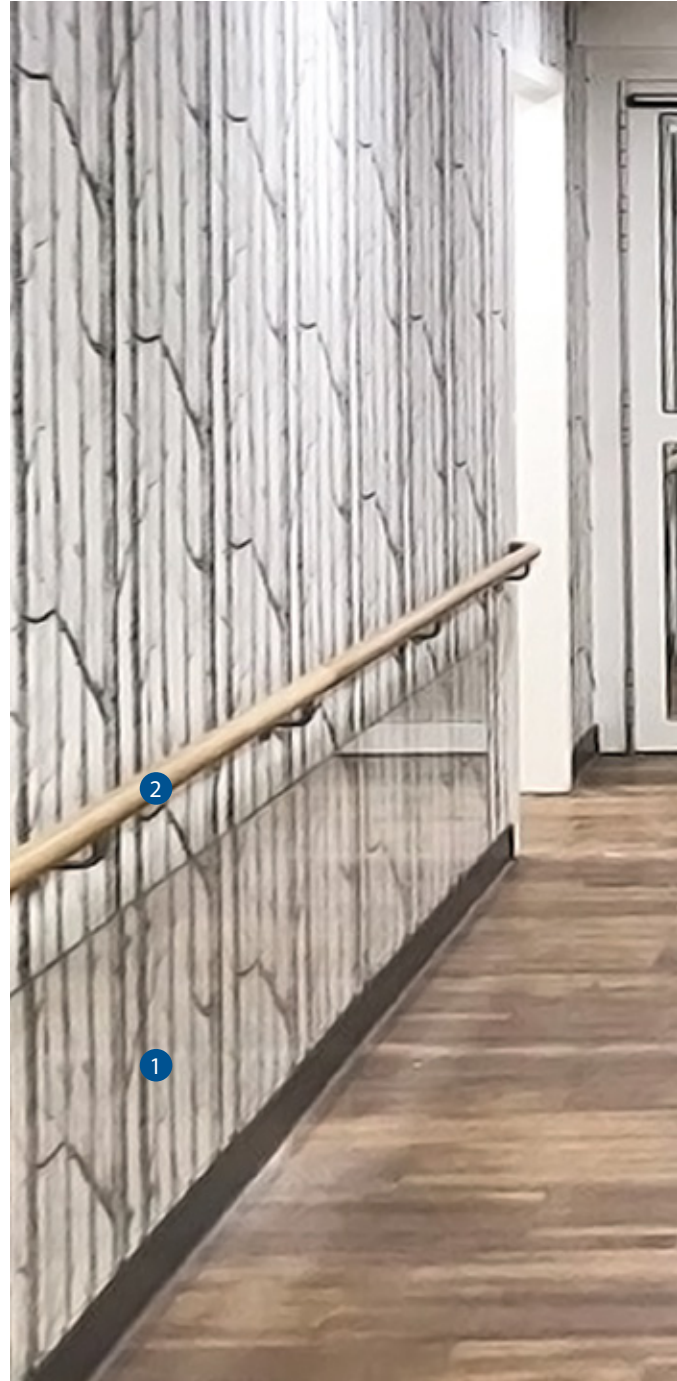

[www.c-sgroup.co.uk/8779](http://www.c-sgroup.co.uk/8779)



## KEY FEATURES

- A1 rated, clear 6mm toughened glass
- High mechanical and thermal resistance  
Tensile strength:  $\sigma_b = 120 \text{ N/mm}^2$   
Sustained stress:  $\sigma_{perm} = 50 \text{ N/mm}^2$   
Temperature differential resistance:  
 $\Delta T$  over the pane area = 200K
- In the event of breaking the material shatters into thousands of small pieces with no sharp edges





- 1 6mm thick clear toughened glass
- 2 HRW-6 Solid Timber Handrail  
Page 78
- 3 6mm thick back-painted toughened glass

## DESIGN OPTIONS

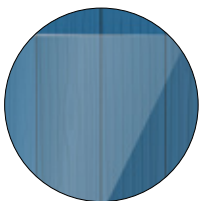

### Clear

Clear glass protects walls without obscuring wall finishes. Great for application with wallpapers.

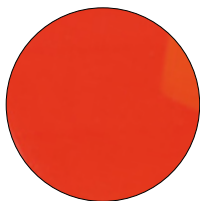

### Painted

Back-painted with a RAL or NCS colour of your choice, glass panels introduce depth, reflection and interest to the interior.



### Printed

Printed with your choice of image or graphic our panels offer limitless design possibilities.



## PRODUCT SPECIFICATION

### Thickness and size

6mm thickness. Supplied to project specific sizes (maximum panel size 2000mm x 1600mm), with cut outs for sockets etc. included. Not suitable for cutting on-site.

### Edge finishing

Edge finish options include: arrised, raw, ground or polished.

### Installation

Screw fixed or installed in a frame. Painted or printed options can also be mounted with an adhesive.

# Acrovyn® Wall Panels

Where heavy duty wall protection is required, Acrovyn Wall Panels provide a cost effective and long lasting solution.

Manufactured to custom specifications by applying one of our impact resistant sheet options to a rigid board, Acrovyn Wall Panels can be used to provide a very durable and easy to maintain surface to the entire wall, or just to half height.

Available in a wide range of colours to suit the project's aesthetic requirements, our panels are designed to withstand high traffic abuse, keeping walls damage free.

 [www.c-sgroup.eu/835](http://www.c-sgroup.eu/835)

## APPLICATIONS:

- Corridors
- Lift areas
- Back-of-house areas
- Full or half height applications

Available in  
a wide range  
of colours.

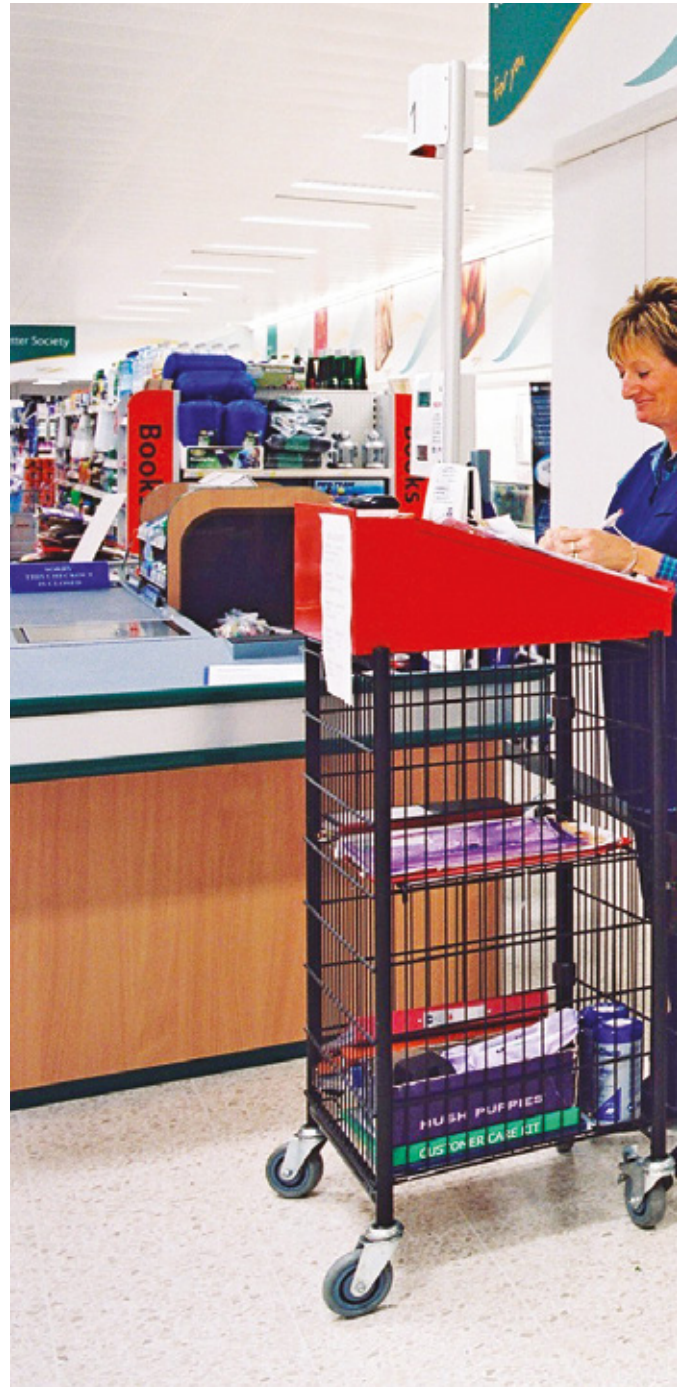

## PRODUCT SPECIFICATION

### Panel finish options

- 2mm Acrovyn Sheet, Suede, 36 colours (**page 34**)
- 2mm Acrovyn Sheet, Smooth, 10 colours (**page 40**)
- 1.5mm Acrovyn PVC-Free Sheet, Suede, 36 colours (**page 38**)

### Board options

9mm MDF as standard. 9mm moisture resistant MDF or MDF fire tested to EN 13501 optional. Other board thicknesses also available.



## EDGE FINISH OPTIONS

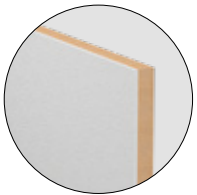

### Face only

Acrovyn facing applied to face only. May require finishing trims in part height applications.



### 2-side wrapped

Square wrapped on two sides, ideal for part height applications with panels installed in a landscape orientation.



### 4-side wrapped

Panel face and all edges are finished with chosen Acrovyn Sheet option. Not suitable for cutting to size on-site.

### Sizes

Standard panel size is 2400mm x 1200mm.\*

\* Sizes within given dimensions are available. Larger panels can be manufactured on request (max 2960mm x 1200mm).

Overall panel thickness will vary, depending on the combination of selected panel finish and board thickness.

### Finishing accessories

Colour matched mastic, aluminium and stainless steel trims available.

### Installation

Fitted directly to a wall substrate using a high build construction adhesive for a permanent fix.

# Acrovyn® FP Wall Panels

Robust, A2 fire rated wall panels designed for areas with high performance requirements.



A2-s1, d0



Class A+

Our Acrovyn FP Wall Panels offer durability and resilience in building areas with A2 fire rating requirements.

Manufactured using gypsum fibre board, the 12.5mm thick panels are finished with a highly durable, abrasion and scratch resistant coating.

An attractive, lightly textured surface finish and a wide range of colour options make it a solution suitable for a variety of building types.

## APPLICATIONS:

- Corridors and escape routes with A2 fire rating requirement
- Entrance and lift areas
- Suitable for full and part height wall applications



[www.c-sgroup.eu/10912](http://www.c-sgroup.eu/10912)

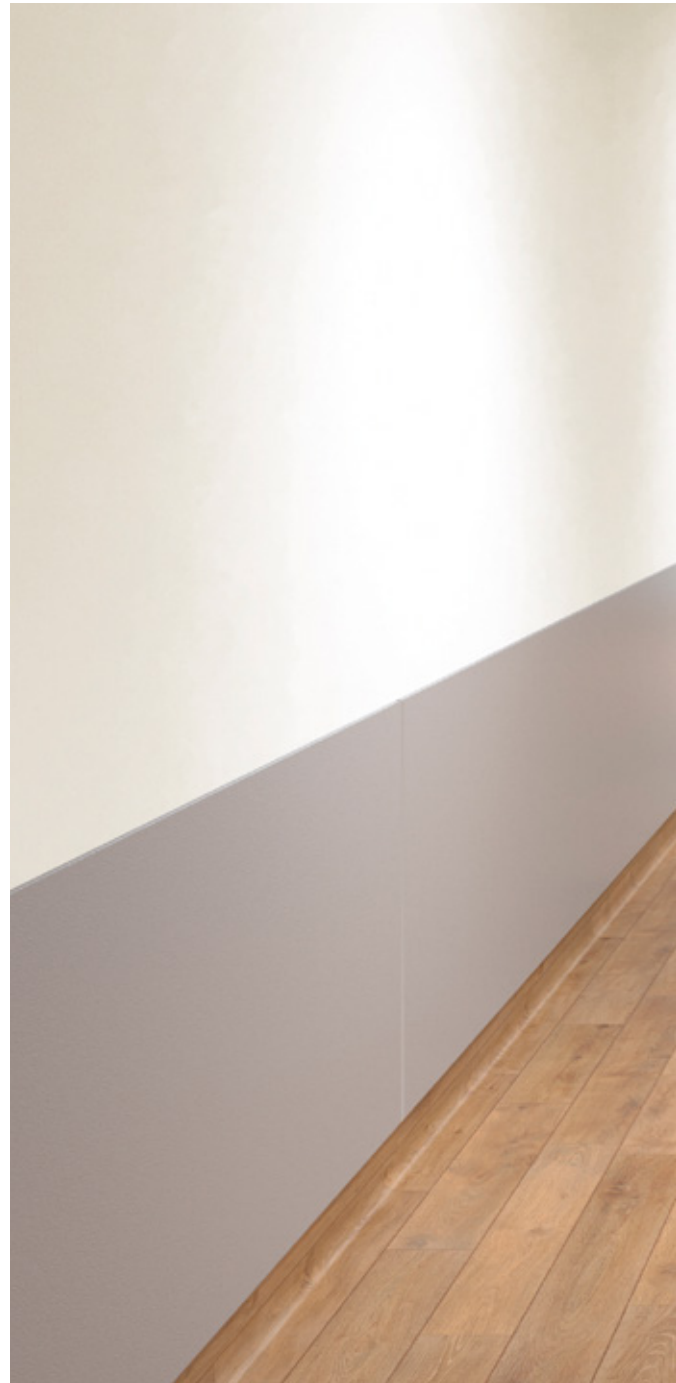

## PRODUCT SPECIFICATION

- 12.5mm panels comprising gypsum fibre board with a lightly textured, highly durable and scratch resistant surface coating
- Supplied prefabricated to project specific sizes. Panels for part height wall applications are 1250mm wide x up to 1250mm high. Panels for full height applications are 1250mm wide x up to 2530mm high. Cutting on site should be avoided.
- Installed with construction adhesive for permanent fix.



## COLOUR OPTIONS

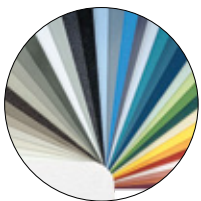

### Acrovyn colours

Panels can be supplied in any of our standard solid colours - see Colour Foldout **page 150**.



### RAL colours

Any RAL colour can be specified to coordinate with the interior decor.

## FINISHING OPTIONS



A coated finish is applied to panel face only, leaving board edges exposed.

Panel edges are straight cut, with a small bevel to vertical edges on the face side only.

Aluminium or stainless steel trims are available for use in part height wall applications.

# Acrovyn® Corner Guards

External wall corners and other structural protrusions in any building are particularly prone to damage, compromising appearance, hygiene and safety.

Durable and easy to clean Acrovyn Corner Guards keep corners intact, hygienic, and significantly reduce maintenance costs.

For optimum protection select models featuring a free floating cover fitted over a continuous aluminium retainer.

Our SO and TF-N ranges provide a simple and easy to install solution for busy corridors and circulation areas.

Available in a range of designs and material options there is an Acrovyn Corner Guard to suit every interior need.

## APPLICATIONS:

- Corridor walls and columns
- Lift lobbies
- Reception and waiting areas
- Food serving and dining areas

 [www.c-sgroup.co.uk/396](http://www.c-sgroup.co.uk/396)

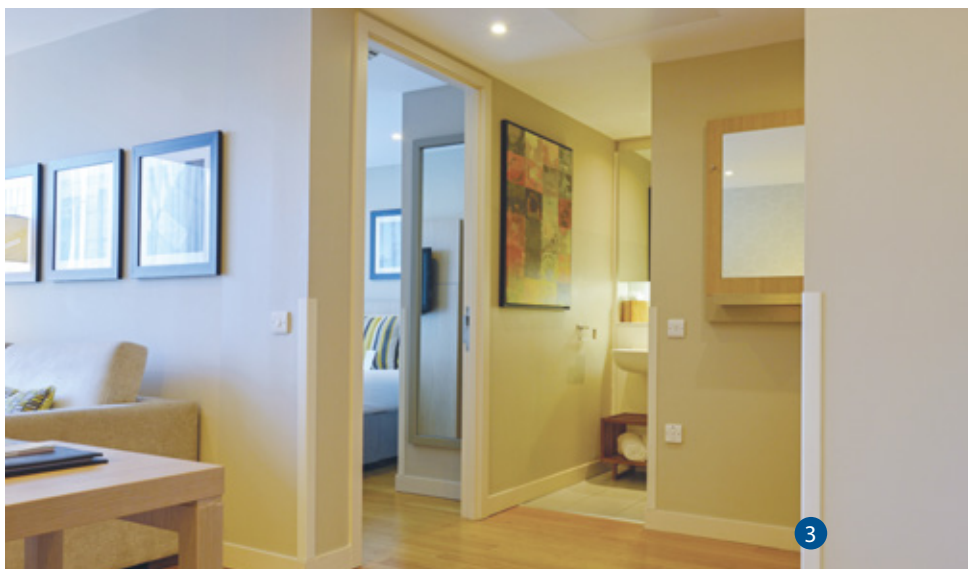

- 1 SM-20 Corner Guard  
Page 64
- 2 Acrovyn Textured Sheet  
Page 34
- 3 SO-50 Corner Guard  
Page 67



Adjustable end caps for installation flexibility.

Acrovyn snap-on cover flexes upon impact and recovers to its original shape. Easily replaceable in case of damage.

SM-20

Robust, continuous aluminium retainer for strength and durability.

Easy to clean textured finish helps to minimise the appearance of scratches and abrasions.







# The Range



## SM-20

● Acrovyn ● Acrovyn PVC-Free

**Leg:** 76mm  
**Angles:** 90°  
**Duty Rating:** Heavy  
**Page 64**



## SSM-20

● Acrovyn ● Acrovyn PVC-Free

**Leg:** 51mm  
**Angles:** 90°  
**Duty Rating:** Heavy  
**Page 65**



## SM-20M

● Acrovyn

**Leg:** 76mm  
**Angles:** 135°  
**Duty Rating:** Heavy  
**Page 66**



## SO

● Acrovyn

**Leg:** 30, 50, 75mm  
**Angles:** 90° or 80° - 175°  
**Duty Rating:** Medium  
**Page 67**



## TF-N

● Acrovyn PVC-Free

**Leg:** Made to order  
**Angles:** 90°  
**Duty Rating:** Medium  
**Page 68**

## Also available:



## Stainless Steel Corner Guards

● Stainless Steel

**Leg:** 30, 50, 75mm  
**Angles:** 90°  
**Duty Rating:** Heavy  
**Page 124**



## EPDM Rubber Corner Guards

● EPDM Rubber

**Leg:** 75, 100mm  
**Angles:** 90°  
**Duty Rating:** Severe  
**Page 134**

 [www.c-sgroup.eu/396](http://www.c-sgroup.eu/396)

# ACROVYN®

## SM-20 Corner Guards

● Acrovyn ● Acrovyn PVC-Free

76mm leg corner guards featuring a robust aluminium retainer and a free floating Acrovyn cover, preventing damage to corners from impact caused by wheeled traffic.

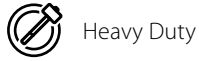

Heavy Duty

 [www.c-sgroup.eu/2551](http://www.c-sgroup.eu/2551)



- 76mm leg corner guards designed for 90° corners
- Impact resistant, textured snap-on cover
- Continuous aluminium retainer for heavy duty protection from impact
- Free floating cover flexes on impact, absorbing its force
- Available in full or dado height cover

### 90° CORNERS



90° CORNERS	
Acrovyn	SM-20
Acrovyn PVC-Free	SM-20N

### COLOURS & TEXTURE



Solid Colours: Acrovyn (27),  
Acrovyn PVC-Free (15)



Texture: Shadowgrain

See Colour Foldout **page 152**.

### STOCK LENGTHS & FIXINGS

- Cut to required size from 3.0m stock lengths
- Fix at staggered 400mm centres

### ACCESSORIES

- Supplied with adjustable top and bottom end caps

ACROVYN®

● Acrovyn ● Acrovyn PVC-Free

# SSM-20 Corner Guards

51mm leg corner guards featuring a robust aluminium retainer and a free floating Acrovyn cover, preventing damage to corners in busy circulation areas.



Heavy Duty



[www.c-sgroup.eu/398](http://www.c-sgroup.eu/398)



- 51mm leg corner guards designed for 90° corners
- Impact resistant, textured snap-on cover
- Continuous aluminium retainer for heavy duty protection from impact
- Free floating cover flexes on impact, absorbing its force
- Solid colours or contemporary woodgrain, concrete and metal finishes
- Available in full or dado height

## 90° CORNERS



90° CORNERS	
Acrovyn	SSM-20
Acrovyn PVC-Free	SSM-20N

## COLOURS & TEXTURE



**Solid Colours:** Acrovyn (27), Acrovyn PVC-Free (15)



**Finishes:** Acrovyn (12): Woodgrains, Metals and Concretes



**Texture:** Shadowgrain

See Colour Foldout **page 151-152.**

## STOCK LENGTHS & FIXINGS

- Cut to required size from 3.0m stock lengths
- Fix at staggered 400mm centres

## ACCESSORIES

- Supplied with adjustable top and bottom end caps

# ACROVYN®

## SM-20M Corner Guards

● Acrovyn

76mm leg corner guards featuring a robust aluminium retainer and a free floating Acrovyn cover, designed to protect 135° corners from impact damage.



Heavy Duty

[www.c-sgroup.eu/16632](http://www.c-sgroup.eu/16632)

- 76mm leg corner guard designed for 135° corners
- Impact resistant, textured snap-on cover
- Free floating cover flexes on impact, absorbing its force
- Continuous aluminium retainer for heavy duty protection from impact
- Available in full or dado height

### 135° CORNERS



SM-20M

### COLOURS & TEXTURE



Solid Colours: Acrovyn (27)



Texture: Shadowgrain

See Colour Foldout **page 152**.

### STOCK LENGTHS & FIXINGS

- Cut to required size from 3.0m stock lengths
- Fix at 400mm centres

### ACCESSORIES

- Supplied with adjustable top and bottom end caps

# ACROVYN® SO Corner Guards

● Acrovyn

30mm, 50mm & 75mm leg, simple to install corner guards, offering economical protection from damage caused by pedestrian and wheeled traffic.



[www.c-sgroup.eu/8495](http://www.c-sgroup.eu/8495)

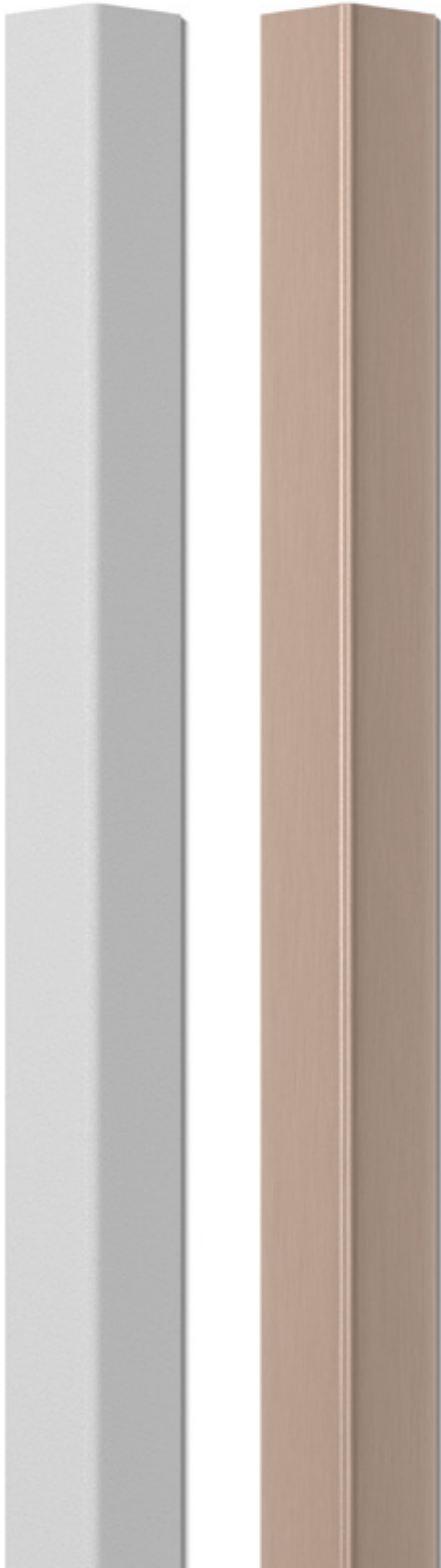

- 30, 50 or 75mm leg corner guards for 90° corners
- 50mm leg co-extruded guard with a flexible corner to suit angles between 80° and 175° available (SO-50V)
- Easy installation with self adhesive foam tape or construction adhesive
- Available in full or dado height, in full range of Acrovyn Sheet colours

## 90° CORNERS

## 80°-180° CORNERS



Acrovyn	90° CORNERS			80°-175° CORNERS
	30MM LEG	50MM LEG	75MM LEG	50MM LEG
	SO-30	SO-50	SO-75	SO-50V

## COLOURS & TEXTURE



**Solid Colours:** Acrovyn Sheet Colours (36)



**Finishes:** SO-50 model only (12): Woodgrains, Metals and Concretes



**Texture:** Shadowgrain

See Colour Foldout **page 150-151**.

## STOCK LENGTHS & FIXINGS

- Cut to required size from 3.0m stock lengths
- Installation using self adhesive foam tape or construction adhesive

## ACCESSORIES

- Can be supplied with or without double sided tape

# ACROVYN®

## TF-N Corner Guards

● Acrovyn PVC-Free

Manufactured to specified sizes, simple to install thermoformed guards designed to provide protection to corners prone to damage.



Medium Duty



Cradle to Cradle Certified™ Bronze



[www.c-sgroup.eu/16631](http://www.c-sgroup.eu/16631)



- PVC-Free corner guards for protection of 90° corners
- Thermoformed from 1.5mm Acrovyn PVC-Free Sheet, Cradle to Cradle Certified™ Bronze
- Available with straight edge for butting up to sheet for a continuous run, or bevelled (round or 45° options)
- Easy installation with self adhesive foam tape or construction adhesive
- Available in heights to suit, in full range of Acrovyn PVC-Free Sheet colours

### 90° CORNERS

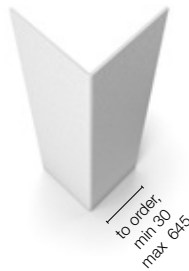

### EDGE OPTIONS



STRAIGHT



ROUND BEVEL



45° BEVEL

### COLOURS & TEXTURE



Solid Colours: Acrovyn PVC-Free Sheet Colours (36)



Texture: Suede

See Colour Foldout **page 150**.

### STOCK LENGTHS & FIXINGS

- Manufactured to required size, max 2.9m
- Installation using self adhesive foam tape or construction adhesive

### ACCESSORIES

- Can be supplied with or without double sided tape
- Edge options: straight, round bevel or 45° bevel



# Acrovyn® Handrails

Designed to provide sturdy mobility support, Acrovyn handrails offer comfort, style and functionality.

With a choice of material options, colours and finishes on offer, our handrails will complement interior design schemes whilst meeting legislation and functional requirements.

Handrails featuring Acrovyn covers are easy to clean and available in a wide selection of colours to provide visual contrast with the wall surface.

Where hygiene is the primary consideration our ISO 22196 certified, Acrovyn with Bactericide handrails provide safe, bacteria free surface.

For a premium look, choose our stainless steel or sustainable timber\* options.

## APPLICATIONS:

- Hospitals, care homes, schools, and other public buildings where handrail support may be required
- Corridors
- Staircases (select options)

 [www.c-sgroup.co.uk/372](http://www.c-sgroup.co.uk/372)



- 1** HRE-6 Acrovyn Handrails with woodgrain finish cover  
**Page 76**
- 2** 2mm Acrovyn Textured Sheet  
**Page 34**
- 3** HRW-6 Solid Timber Handrails  
**Page 78**

*\* All our timber comes from sustainable sources and carries FSC or PEFC certification.*





Woodgrain, concrete or metal finish covers combine attractive looks with functionality and durability of Acrovyn.

For full range of finishes see our Colour Foldout **page 151**.

Infill strip closes off retainer groove for ease of cleaning.

HRE-6

Continuous aluminium retainer for stability and durability.

A choice of aluminium and stainless steel brackets to suit aesthetic, legislation and budget requirements.



# The Range



## HREB-6

● Acrovyn Bactericide

**Size:** 40mm Ø

**Brackets:** Stainless steel or aluminium

**Page 74**



## HRE-6

● Acrovyn

**Size:** 40mm Ø

**Brackets:** Stainless steel or aluminium

**Page 76**



## HR-6N

● Acrovyn PVC-Free

**Size:** 40mm Ø

**Brackets:** Stainless steel

**Page 77**



## HRW-6

● Timber

**Size:** 40mm Ø

**Brackets:** Stainless steel

**Page 78**



## HRS-6

● Stainless Steel

**Size:** 40mm Ø

**Brackets:** Stainless steel

**Page 79**



## HRA-6

● Aluminium

**Size:** 40mm Ø

**Brackets:** Aluminium or stainless steel

**Page 80**



## HRO-6

● Acrovyn ● Acrovyn PVC-Free

**Size:** 38mm wide oval

**Brackets:** Stainless steel or aluminium

**Page 81**



 [www.c-sgroup.eu/372](http://www.c-sgroup.eu/372)

# ACROVYN®

## HREB-6 Handrails

● Acrovyn Bactericide

40mm circular handrail featuring smooth cover with bactericidal additives, providing sturdy pedestrian support in hygienic environments.



Medium Duty



Bactericidal Certified



[www.c-sgroup.eu/6851](http://www.c-sgroup.eu/6851)

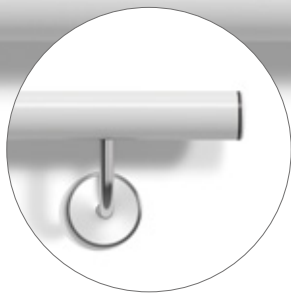

- Ergonomically designed, 40mm Ø handrail with smooth cover over continuous aluminium retainer
- Bactericidal additives in the cover pro-actively kill bacteria on its surface (tested to ISO 22196)
- Infill strip closes off retainer groove for ease of cleaning
- Choice of brackets
- Can be installed to curved walls (min. 1m radius)

### COLOURS & TEXTURE



Solid Colours: Acrovyn Bactericide (27)



Texture: Smooth

See Colour Foldout **page 152**.

### ALUMINIUM BRACKETS

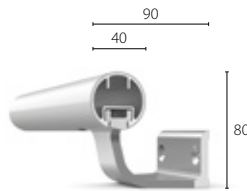

HREB-6-A80

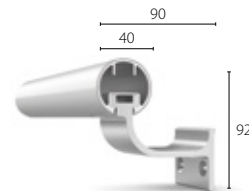

HREB-6-A60

### STAINLESS STEEL BRACKETS

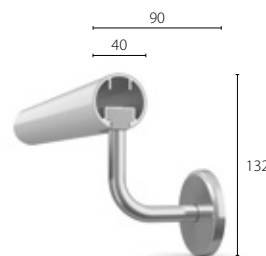

HREB-6-S75

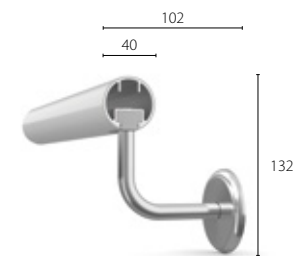

HREB-6-S87 BS 8300 Compliant

### STOCK LENGTHS & FIXINGS ACCESSORIES

- Acrovyn: 4.0m
- Brackets at max. 800mm centres; fixing into studwork or pattresses is recommended
- End caps or end stops
- External, internal and odd angle corners (98° – 165°)
- Stainless steel or aluminium brackets (including options for radiused installations)
- Vertical accent trims (optional) - Black (standard) or Light Grey
- Universal corner adaptor for staircase installations
- Removable kit for service ducts



## TESTED AND CERTIFIED

Acrovyn Bactericide has been tested to ISO 22196 for its bactericidal efficacy against 7 common species.

Classified under EN 1040. For further details see **page 10**

### Escherichia coli



Activity in log: 5.4  
Class: Bactericidal

### Staphylococcus aureus



Activity in log: 5.1  
Class: Bactericidal

### Mycobacterium smegmatis



Activity in log: >5  
Class: Bactericidal

### MRSA\*

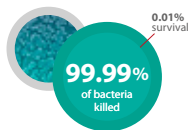

Activity in log: 3.92  
Class: Bacteriostatic

### Salmonella enteritidis

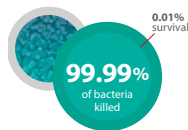

Activity in log: 4.1  
Class: Bacteriostatic

### Listeria monocytogenes



Activity in log: 2.661  
Class: Bacteriostatic

### Enterococcus species

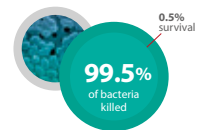

Activity in log: 2.28  
Class: Bacteriostatic

\*Methicillin-resistant *Staphylococcus aureus*

## CORNER ADAPTOR FOR STAIRS

Our universal corner adaptor makes it easy to install continuous runs of handrails in staircases.



Rotation around two axes allows the adaptor to accommodate any required angle and staircase configuration.

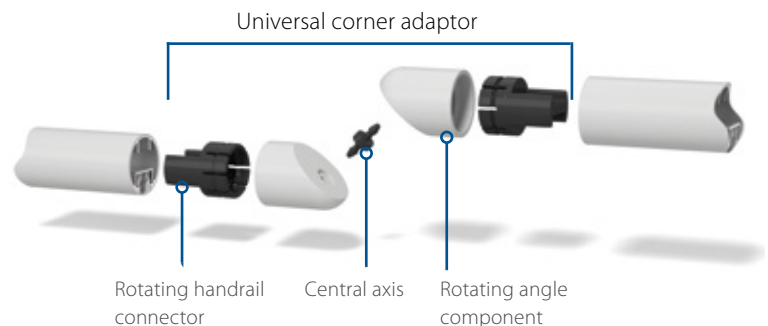

Continuous handrail application connecting staircase with floor level handrails can be easily achieved.

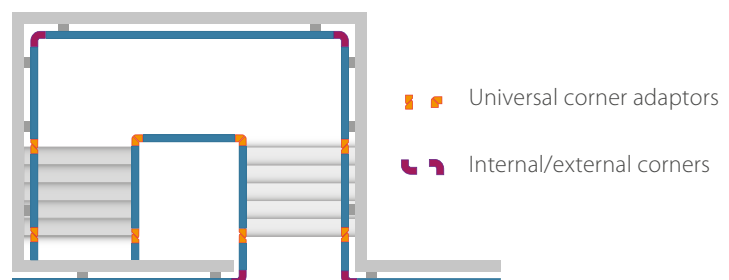

# ACROVYN®

## HRE-6 Handrails

 Acrovyn

40mm circular handrail combining contemporary decorative finishes with ease of maintenance of Acrovyn.

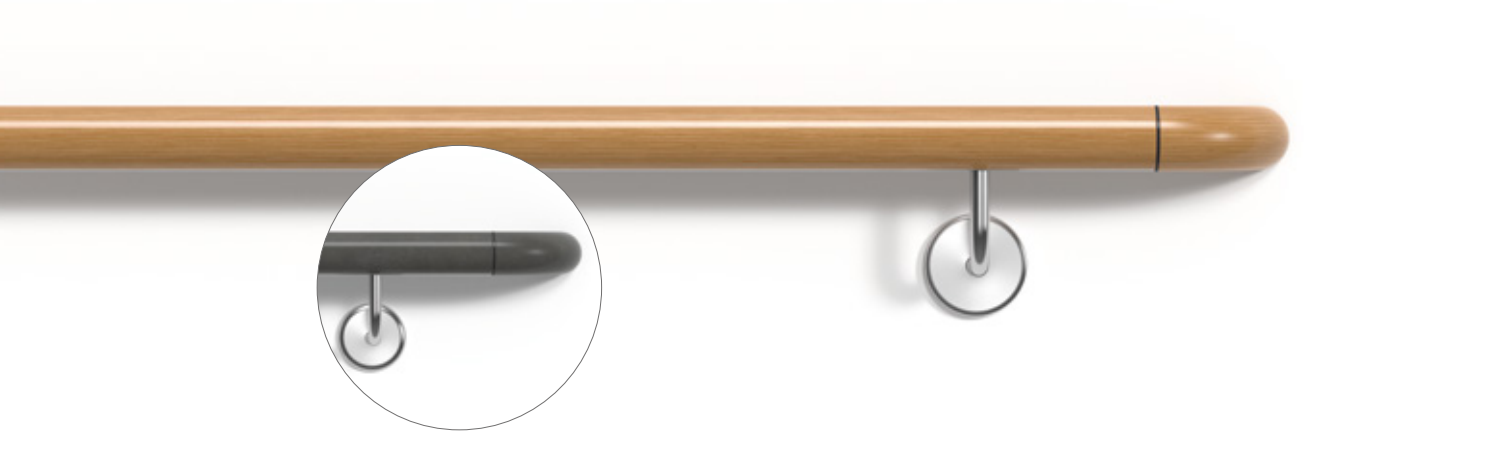
 [www.c-sgroup.eu/6853](http://www.c-sgroup.eu/6853)

- Ergonomically designed, 40mm Ø handrail with smooth cover in a range of contemporary finishes
- Continuous aluminium retainer for sturdy support
- Infill strip closes off retainer groove for ease of cleaning
- Choice of brackets
- Can be installed to curved walls (min. 1m radius)

### COLOURS & TEXTURE



**Finishes:** Acrovyn (12) - Woodgrains, Metals and Concretes



**Texture:** Smooth

See Colour Foldout **page 151**.

### ACCESSORIES

- End caps or end stops
- External, internal and odd angle corners (98° – 165°)
- Stainless steel or aluminium brackets (including options for radiused installations)

### ALUMINIUM BRACKETS

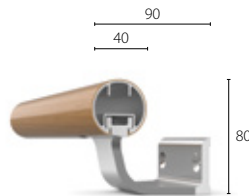

HRE-6-A80

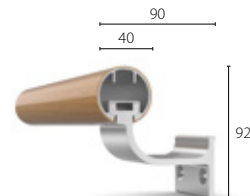

HRE-6-A60

### STAINLESS STEEL BRACKETS

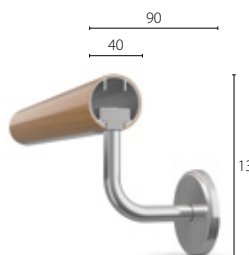

HRE-6-S75

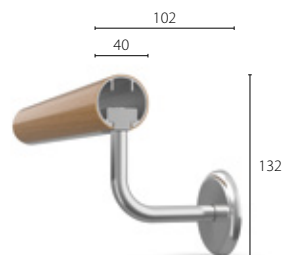

HRE-6-S87  BS 8300 Compliant

### STOCK LENGTHS & FIXINGS

- Universal corner adaptor for staircase installations (available from November 2022)
- Vertical accent trims (optional) - Black (standard) or Light Grey
- Removable kit for service ducts
- Acrovyn: 4.0m
- Brackets at max. 800mm centres; fixing into studwork or pattresses is recommended

ACROVYN®

● Acrovyn PVC-Free

# HR-6N Handrails

40mm circular handrail featuring textured Acrovyn PVC-Free cover, providing comfortable mobility support in corridors.



Medium Duty



[www.c-sgroup.eu/374](http://www.c-sgroup.eu/374)



- Ergonomically designed, 40mm Ø handrail with textured cover
- Continuous aluminium retainer for sturdy support
- Grooveless retainer design for ease of cleaning
- Choice of brackets
- Can be installed to curved walls (min. 1m radius)

## STAINLESS STEEL BRACKETS

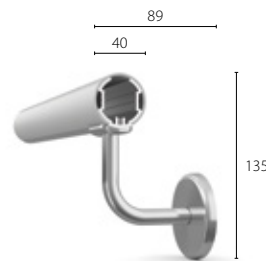

HR-6N-S75

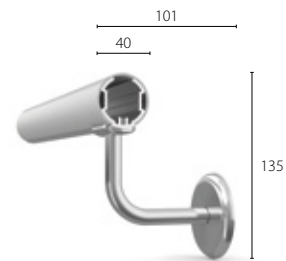

HR-6N-S87 BS 8300 Compliant

## COLOURS & TEXTURE



**Solid Colours:** Acrovyn PVC-Free (15)



**Texture:** Shadowgrain

See Colour Foldout **page 152**.

## ACCESSORIES

- End caps
- External and internal corners
- Stainless steel brackets
- Clear collar (optional) for end caps and corner pieces

## STOCK LENGTHS & FIXINGS

- Acrovyn PVC-Free: 3.0m
- Brackets at max. 800mm centres; fixing into studwork or pattresses is recommended

# ACROVYN®

## HRW-6 Handrails

● Timber

40mm solid timber handrail combining a luxury feel and natural look with comfortable mobility support.



Medium Duty



[www.c-sgroup.eu/381](http://www.c-sgroup.eu/381)

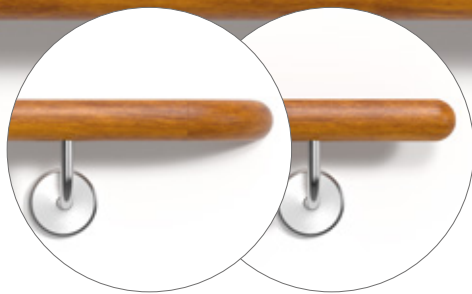

- Sustainably sourced, 40mm Ø solid timber handrail
- Choice of end caps (timber or stainless steel), rounded timber end stops or rounded integral rail ends
- Untreated timber for finishing on site as standard, or can be supplied in custom sizes in a selection of varnish options upon request
- Choice of brackets
- Can be installed to curved walls (min. 800mm radius)

### STAINLESS STEEL BRACKETS

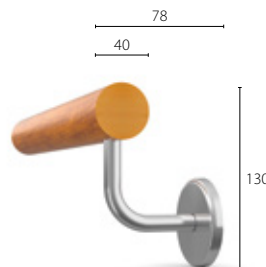

HRW-6-S75

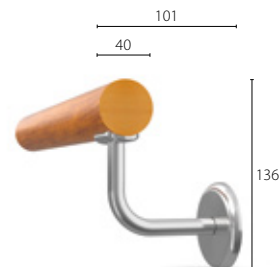

HRW-6-S87 BS 8300 Compliant

### MATERIAL & FINISH



**Timber\***: Oak, Beech or Maple

Timber is supplied untreated as standard. Custom size, ready-to-install handrail kits are available on request in Natural, Golden or Walnut varnish options.

See Colour Foldout **page 151**.

\* All our timber comes from sustainable sources and carries FSC or PEFC certification.

### ACCESSORIES

- Stainless steel or timber end caps
- Stainless steel or timber internal and external corners
- Rounded timber end stops (untreated); rounded integral rail ends also available for handrail kits



- Stainless steel brackets

### STOCK LENGTHS & FIXINGS

- Lengths: Varies, depending on timber species and availability
- Brackets at max. 800mm centres; fixing into studwork or pattresses is recommended



ACROVYN®

● Stainless Steel

# HRS-6 Handrails

40mm, highly durable, stainless steel handrail offering a sleek and modern aesthetic in hygiene sensitive areas.



Medium Duty



[www.c-sgroup.eu/376](http://www.c-sgroup.eu/376)



- 40mm Ø stainless steel handrail
- Supplied prefabricated to surveyed lengths with welded end caps for easy installation
- Choice of brackets
- Easy to clean and maintain solution for hygienic environments
- Can be installed to curved walls (min. 500mm radius)

## STAINLESS STEEL BRACKETS

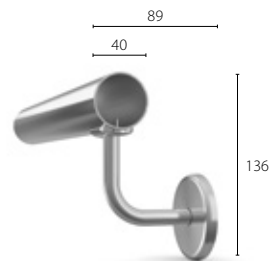

HRS-6-S75

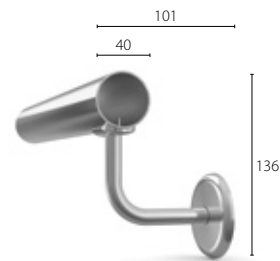

HRS-6-S87 BS 8300 Compliant

## MATERIAL & FINISH



**Material:** Grade 304 stainless steel



**Finish:** Brushed

## ACCESSORIES

- Stainless steel end caps
- Stainless steel internal and external corners
- Stainless steel brackets

## STOCK LENGTHS & FIXINGS

- Lengths to cutting schedule from stock lengths of max 3.0m
- Brackets at max. 800mm centres; fixing into studwork or pattresses is recommended

# ACROVYN®

## HRA-6 Handrails

● Aluminium

40mm circular, anodised aluminium handrail offering durable and comfortable mobility support.



Medium Duty



[www.c-sgroup.eu/6855](http://www.c-sgroup.eu/6855)



- 40mm Ø anodised aluminium handrail
- Infill strip closes off retainer groove for ease of cleaning
- Choice of brackets
- Can be installed to curved walls (min. 1m radius)

### MATERIAL & FINISH



Material: Aluminium



Finish: Clear anodised

### ACCESSORIES

- End caps
- External, internal and odd angle corners (98° to 165°)
- Stainless steel or aluminium brackets (including option for radiused installations)

### ALUMINIUM BRACKETS

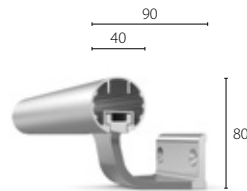

HRA-6-A80



HRA-6-A60

### STAINLESS STEEL BRACKETS

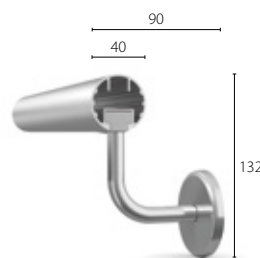

HRA-6-S75

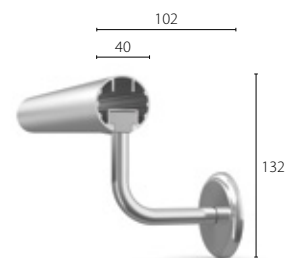

HRA-6-S87 BS 8300 Compliant

### STOCK LENGTHS & FIXINGS

- Vertical accent trims (optional) - Black (standard) or Light Grey
- Removable kit for service ducts

- Aluminium: 4.0m
- Brackets at max. 800mm centres; fixing into studwork or pattresses is recommended

ACROVYN®

● Acrovyn ● Acrovyn PVC-Free

# HRO-6 Handrails

38mm wide, ergonomically designed oval handrail providing comfortable grip and firm support in circulation corridors.



Medium Duty



[www.c-sgroup.eu/6847](http://www.c-sgroup.eu/6847)

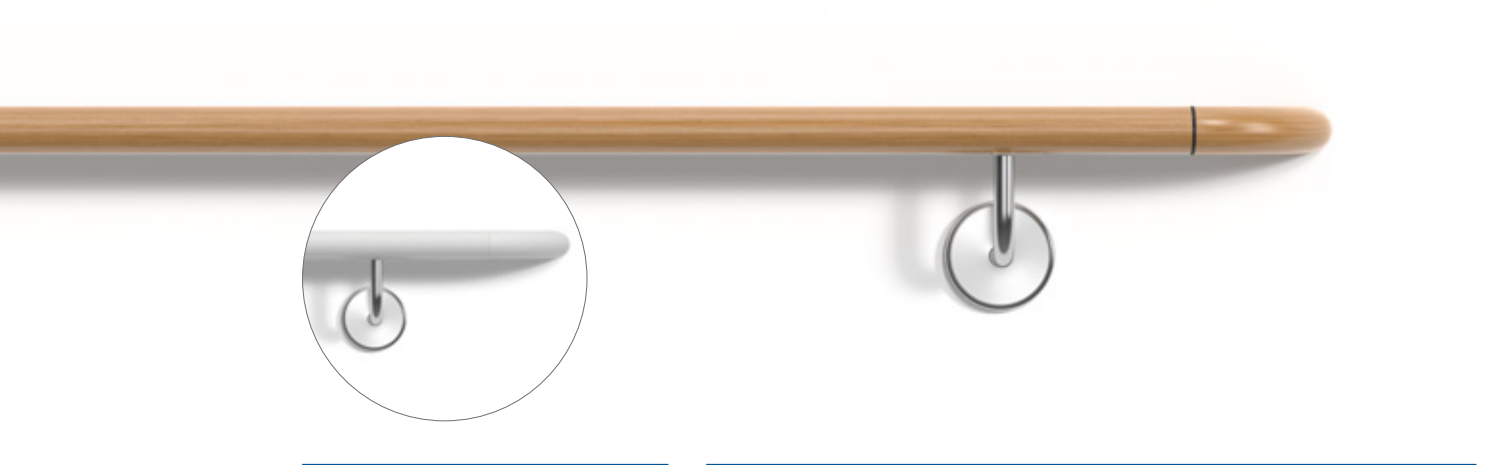

- 38mm wide, oval handrail with textured cover
- Continuous aluminium retainer for sturdy support
- Infill strip closes off retainer groove for ease of cleaning
- Available in a range of solid colours and contemporary finishes
- Choice of brackets

## STAINLESS STEEL BRACKET ALUMINIUM BRACKET

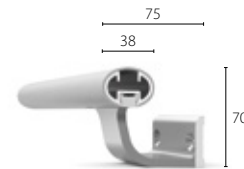
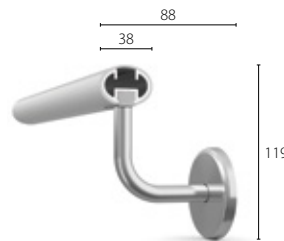

PRODUCT CODES	STAINLESS STEEL BRACKET	ALUMINIUM BRACKET
<b>Acrovyn</b>	HRO-6-S75	HRO-6-A80
<b>Acrovyn PVC-Free</b>	HRO-6N-S75	HRO-6N-A80

## COLOURS & TEXTURE



**Solid Colours:** Acrovyn (27), Acrovyn PVC-Free (15)



**Finishes:** Acrovyn only (12)  
- Woodgrains, Metals and Concretes



**Texture:** Shadowgrain

See Colour Foldout **pages 151-152.**

## ACCESSORIES

- End caps
- External and internal corners
- End stops in Black or Grey (for Acrovyn models only)
- Stainless steel or aluminium brackets
- Vertical accent trims (optional) - Black (standard) or Light Grey
- Removable kit for service ducts

## STOCK LENGTHS & FIXINGS

- Acrovyn: 4.0m  
Acrovyn PVC-Free: 3.0m
- Brackets at max. 800mm centres; fixing into studwork or pattresses is recommended

# Acrovyn® Hand/ Crash Rails

Elegant and ergonomically designed, Acrovyn Hand/ Crash Rails provide impact protection and pedestrian support in circulation areas. They are available in a variety of styles to suit aesthetic and functional requirements, and include anti-ligature solutions.

Through-coloured, textured covers hide the effects of impact damage or abrasion, and are easy to clean.

Top handrail sections on some models can be specified in a contrasting colour for visual guidance.

## APPLICATIONS:

- Corridors with pedestrian access and regular trolley movement
- Lift lobbies and lifts
- Circulation areas with anti-ligature handrail requirements

 [www.c-sgroup.eu/133](http://www.c-sgroup.eu/133)



- 1 HRB-20 Hand/Crash Rail with contrasting cover colours  
**Page 86**
- 2 2mm Acrovyn Textured Sheet  
**Page 34**
- 3 SO-50 Corner Guard  
**Page 67**
- 4 HRB-4C Hand/Crash Rail  
**Page 87**
- 5 SM-20 Corner Guard  
**Page 64**



HRB-20

Acrovyn handrail cover provides a warm and comfortable grip. Contrasting handrail colour can be specified for visual guidance.

Crash rail cover flexes under impact. Textured finish helps to minimise the appearance of scratches and abrasions.

Quick Lock bracket for fast installation and easy maintenance. See **page 89** for further details.

Continuous aluminium retainer fitted with Acrovyn re-grind bumper cushion absorbs the impact energy and dissipates it along the length.





# The Range

## HRB-20

● Acrovyn ● Acrovyn PVC-Free



**Height:** 143mm

**Duty Rating:** Heavy

**Page 86**

## HRB-4C

● Acrovyn ● Acrovyn PVC-Free



**Height:** 140mm

**Duty Rating:** Severe

**Page 87**

## HRB-35

● Acrovyn ● Acrovyn PVC-Free



**Height:** 89mm

**Duty Rating:** Heavy

**Page 88**



## HRB-50N

● Acrovyn PVC-Free



**Height:** 220mm

**Duty Rating:** Heavy

**Page 90**

## HRBW-50N

● Timber ● Acrovyn PVC-Free



**Height:** 220mm

**Duty Rating:** Heavy

**Page 91**



 [www.c-sgroup.eu/133](http://www.c-sgroup.eu/133)

# ACROVYN®

## HRB-20 Hand/Crash Rails

● Acrovyn ● Acrovyn PVC-Free

143mm high hand/crash rails offering pedestrian support and heavy duty impact protection. Two colours can be used to provide visual contrast.



Quick Lock



Heavy Duty



Dual Colour



[www.c-sgroup.eu/134](http://www.c-sgroup.eu/134)

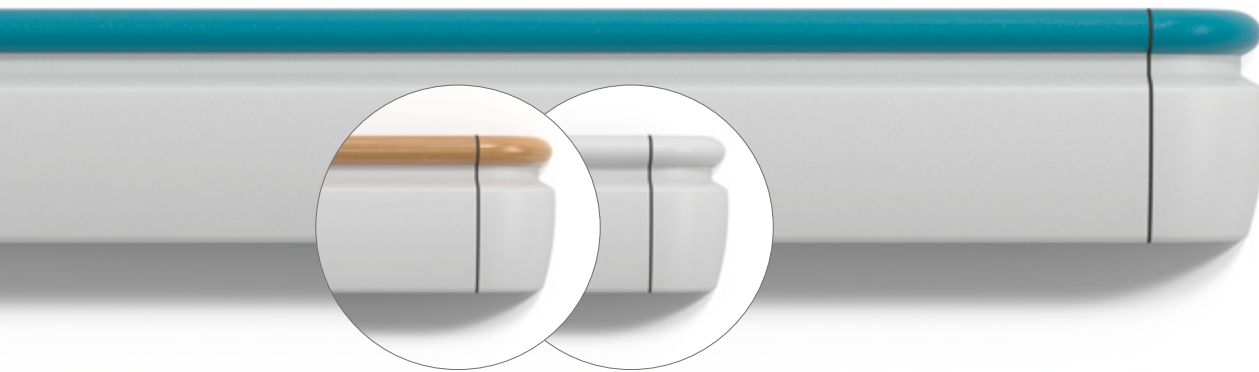

- Comfortable grip handrail available in solid colours and contemporary finishes
- Two colours can be used for visual contrast or in wayfinding schemes
- Impact resistant crash rail cover over continuous aluminium retainer and bumper cushion for effective damage protection
- Quick Lock brackets for fast installation and easy maintenance
- Infill strip closes off retainer channel for ease of cleaning
- Anti-ligature option featuring continuous, powder coated aluminium bracket

### QUICK LOCK

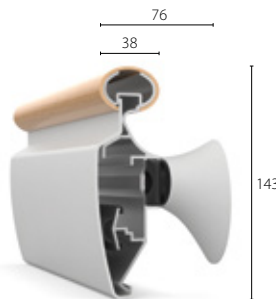

### ANTI-LIGATURE

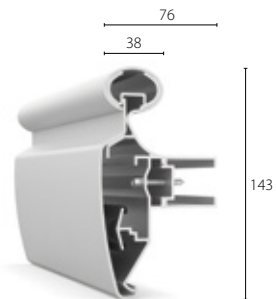

PRODUCT CODES	QUICK LOCK	ANTI-LIGATURE
<b>Acrovyn</b>	HRB-20	HRB-20AL
<b>Acrovyn PVC-Free</b>	HRB-20N	HRB-20ALN

### COLOURS & TEXTURE



**Solid Colours:** Acrovyn (27)  
Acrovyn PVC-Free (15)



**Finishes:** Acrovyn Handrail only (12) - Woodgrains, Metals and Concretes



**Texture:** Shadowgrain

See Colour Foldout **pages 151-152.**

### ACCESSORIES

- End caps with Quick Lock feature
- External corners
- Quick Lock brackets (standard)
- Anti-ligature brackets (optional)
- Vertical accent trims (optional) - Black (standard) or Light Grey
- Removable kit for service ducts

### STOCK LENGTHS & FIXINGS

- Acrovyn - 4.0m  
Acrovyn PVC-Free - 3.0m
- Brackets at max. 800mm centres; fixing into studwork or pattresses is recommended



ACROVYN®

● Acrovyn ● Acrovyn PVC-Free

# HRB-4C Hand/Crash Rails

140mm high hand/crash rail in a classic, flat profile, offering severe duty impact protection and mobility support in circulation routes.



Quick Lock



Severe Duty



[www.c-sgroup.eu/371](http://www.c-sgroup.eu/371)



- Comfortable grip handrail top
- Free-floating cover flexes on impact, neutralising its force
- Continuous shock-absorbing cushion for increased impact protection
- Quick Lock brackets for fast installation and easy maintenance
- Infill strip closes off retainer channel for ease of cleaning
- Anti-ligature option featuring continuous, powder coated aluminium bracket

## QUICK LOCK

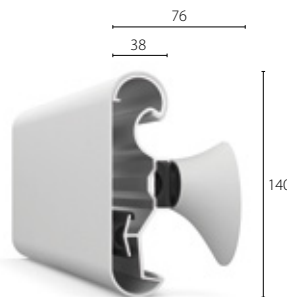

## ANTI-LIGATURE

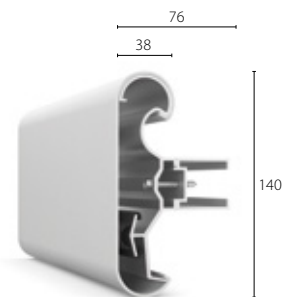

PRODUCT CODES	QUICK LOCK	ANTI-LIGATURE
Acrovyn	HRB-4C	HRB-4CAL
Acrovyn PVC-Free	HRB-4CN	HRB-4CALN

## COLOURS & TEXTURE



Solid Colours: Acrovyn (27)  
Acrovyn PVC-Free (15)



Texture: Shadowgrain

See Colour Foldout **page 152**.

## ACCESSORIES

- End caps
- External corners
- Quick Lock brackets (standard)
- Anti-ligature brackets (optional)
- Vertical accent trims (optional) - Black (standard) or Light Grey
- Removable kit for service ducts

## STOCK LENGTHS & FIXINGS

- Acrovyn - 4.0m  
Acrovyn PVC-Free - 3.0m
- Brackets at max. 800mm centres; fixing into studwork or pattresses is recommended

ACROVYN®

● Acrovyn ● Acrovyn PVC-Free

# HRB-35 Hand/Crash Rails

89mm high hand/crash rails in a stylish curved design offering comfortable grip and heavy duty protection with minimum visual impact.



Quick Lock



Heavy Duty

[www.c-sgroup.eu/6865](http://www.c-sgroup.eu/6865)

- Comfortable grip handrail top
- Free-floating, curved cover design flexes on impact, neutralising its force
- Optional vertical accent trim at the joint between the end cap and the cover
- Quick Lock brackets for fast installation and easy maintenance
- Infill strip closes off retainer channel for ease of cleaning

## QUICK LOCK



PRODUCT CODES	QUICK LOCK
Acrovyn	HRB-35
Acrovyn PVC-Free	HRB-35N

## COLOURS & TEXTURE



Solid Colours: Acrovyn (27)  
Acrovyn PVC-Free (15)



Texture: Shadowgrain

See Colour Foldout **page 152**.

## ACCESSORIES

- End caps with Quick Lock feature
- External corners
- Quick Lock brackets
- Vertical accent trims (optional) - Black (standard) or Light Grey
- Removable kit for service ducts

## STOCK LENGTHS & FIXINGS

- Acrovyn - 4.0m  
Acrovyn PVC-Free - 3.0m
- Brackets at max. 800mm centres; fixing into studwork or pattresses is recommended

ACROVYN®

# QUICK LOCK™ for Hand/Crash Rails

CS' sturdy and efficient fixing system makes the installation of Acrovyn Hand/Crash Rails a simple, clean process.



## HOW DOES IT WORK?:

The unique cam lock on the bracket simply slots into the back of the retainer, and the profile is locked or unlocked with the twist of a spanner. This allows faster installation, but also enables fast removal for maintenance, without compromising the integrity of the wall fixings.

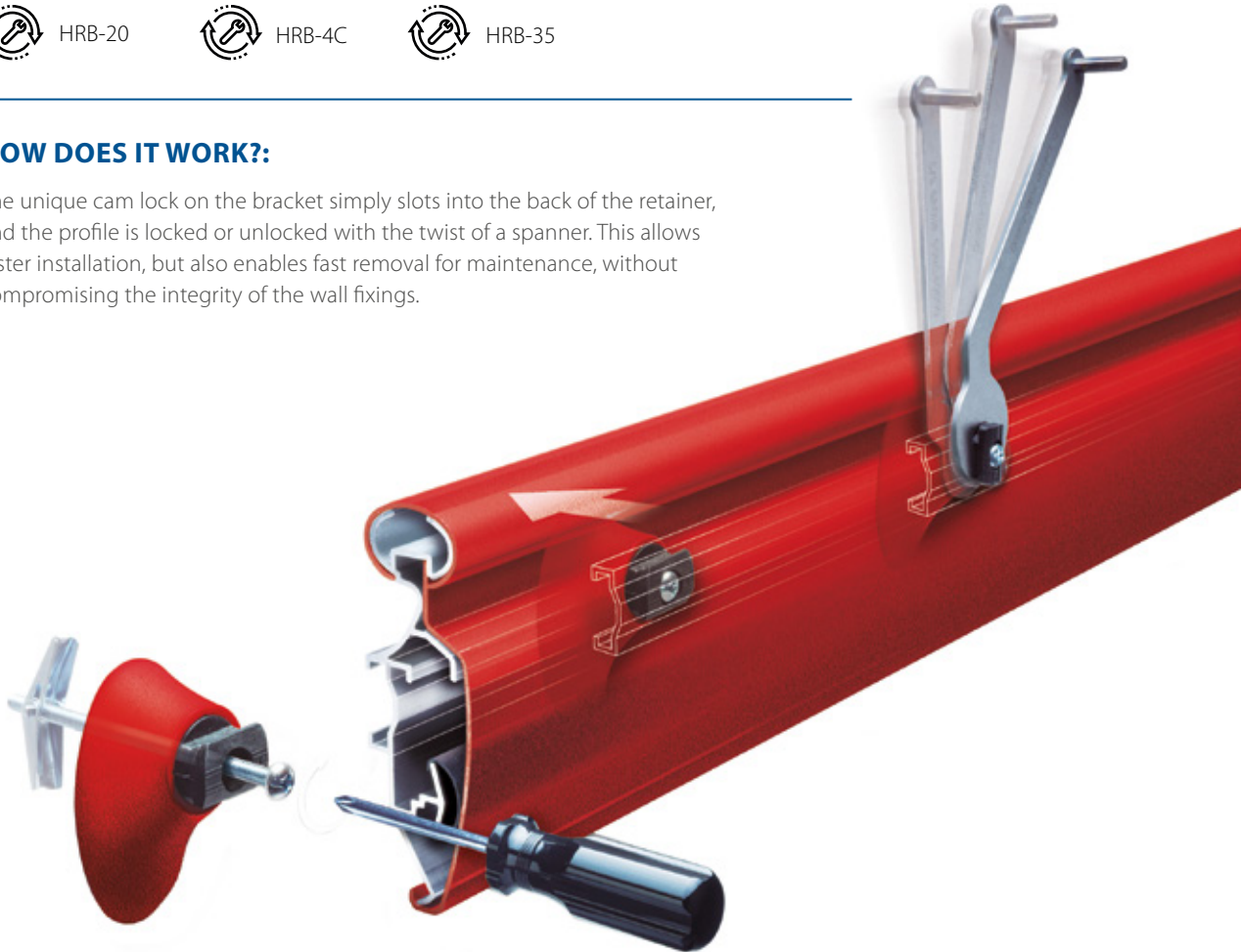

HRB-20 & HRB-35 profiles also feature Quick Lock end caps, which allow fast assembly of the profile without the need for drilling end cap fixing holes.

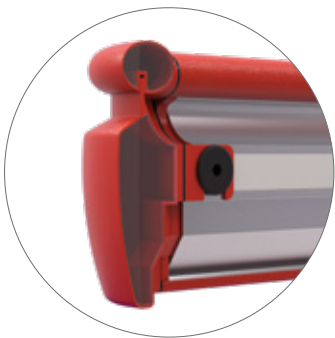

## BENEFITS:

- No more drilling holes in the retainer
- No more struggling with component alignment
- Ease of bracket location and attachment
- Allows for pre-assembly of retainer, cover and end caps off-site
- Allows for easy maintenance
- Offers long term savings

 [www.c-sgroup.eu/3055](http://www.c-sgroup.eu/3055)

ACROVYN®

● Acrovyn PVC-Free

# HRB-50N Hand/Crash Rails

220mm high, HRB-50N combines a PVC-Free handrail and crash rail on a stainless steel bracket to provide mobility support and impact protection.



Heavy Duty



Dual Colour

[www.c-sgroup.eu/369](http://www.c-sgroup.eu/369)

- Code compliant hand/crash rail for busy circulation areas
- 40mm Ø handrail with textured cover over aluminium retainer for secure, comfortable grip
- 127mm high crash rail with curved cover over continuous aluminium retainer and shock-absorbing cushion for effective impact protection
- Infill strip closes off retainer channel for ease of cleaning
- Mounted on robust stainless steel brackets

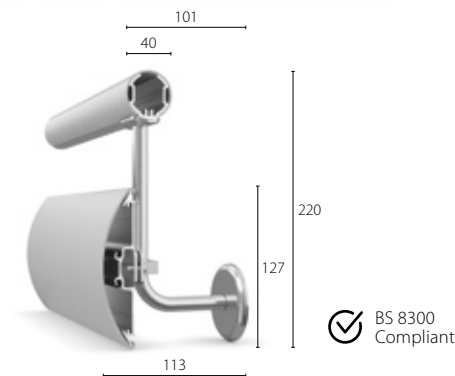

## COLOURS & TEXTURE



**Solid Colours:** Acrovyn PVC-Free (15)



**Texture:** Shadowgrain

See Colour Foldout **page 152**.

## ACCESSORIES

- End caps
- External corners
- Internal corners available for handrail part
- Stainless steel mounting brackets
- Vertical accent trims/ collars (optional) - **handrail:** clear; **crash rail:** Black (standard) or Light Grey

## STOCK LENGTHS & FIXINGS

- Acrovyn PVC-Free - 3.0m
- Brackets at max. 800mm centres; fixing into studwork or pattresses is recommended

ACROVYN®

● Timber

● Acrovyn PVC-Free

# HRBW-50N Hand/Crash Rails

220mm high, HRBW-50N combines a solid timber handrail and a PVC-Free crash rail on a stainless steel bracket to provide mobility support and impact protection.



Heavy Duty



Dual Colour



[www.c-sgroup.eu/16725](http://www.c-sgroup.eu/16725)



- Stylish, code compliant hand/crash rails for busy circulation areas
- 40mm Ø solid timber handrail with stainless steel accessories for secure, comfortable grip
- 127mm high crash rail with curved cover over continuous aluminium retainer and shock-absorbing cushion for effective impact protection
- Infill strip closes off retainer channel for ease of cleaning
- Mounted on robust stainless steel brackets

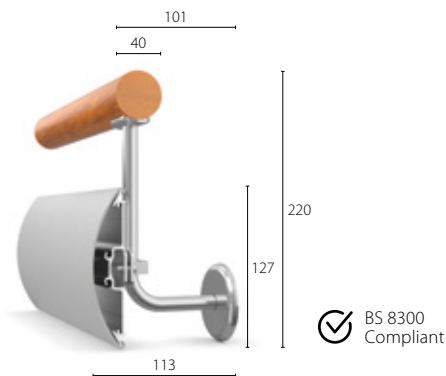

## COLOURS & TEXTURE



**Timber\***: handrail - Oak, Beech or Maple

Timber is supplied untreated as standard. Custom size, ready-to-install handrail kits are available on request in Natural, Golden or Walnut varnish options.



**Solid Colours**: crash rail - Acrovyn PVC-Free (15)



**Texture**: crash rail - Shadowgrain

See Colour Foldout **pages 151-152**.

## ACCESSORIES

- Handrail: stainless steel end caps, internal and external corners
- Crash rail: end caps and external corners
- Stainless steel mounting brackets
- Vertical accent trims for crash rail (optional): Black (standard) or Light Grey

\* All our timber comes from sustainable sources and carries FSC or PEFC certification.

## STOCK LENGTHS & FIXINGS

- Timber handrail: varies depending on species and availability
- Acrovyn PVC-Free crash rail - 3.0m
- Brackets at max. 800mm centres; fixing into studwork or pattresses is recommended

# Acrovyn® Crash Rails

Our wide range of Crash Rails offers a perfect wall protection solution for every need and location, helping to keep your premises in flawless conditions.

Durable Acrovyn profiles are available in a wide range of styles and heights to suit your aesthetic and functional protection requirements.

Textured and through-coloured covers effectively hide the effects of scratches or abrasion, and are easy to clean to help maintain the appearance of interior walls.

Our contemporary range of colours and finishes will complement other interior decor elements in all building areas.

## APPLICATIONS:

- Circulation corridors with frequent trolley or bed movement
- Production areas and laboratories
- Back-of-house areas in retail facilities and hotels
- Receptions and waiting areas

 [www.c-sgroup.eu/608](http://www.c-sgroup.eu/608)



- 1 SCR-80M Crash Rail  
**Page 96**
- 2 SM-20 Corner Guard  
**Page 64**
- 3 Push Plate  
**Page 142**
- 4 Kick Plate  
**Page 142**
- 5 SCR-150N Crash Rail  
**Page 102**

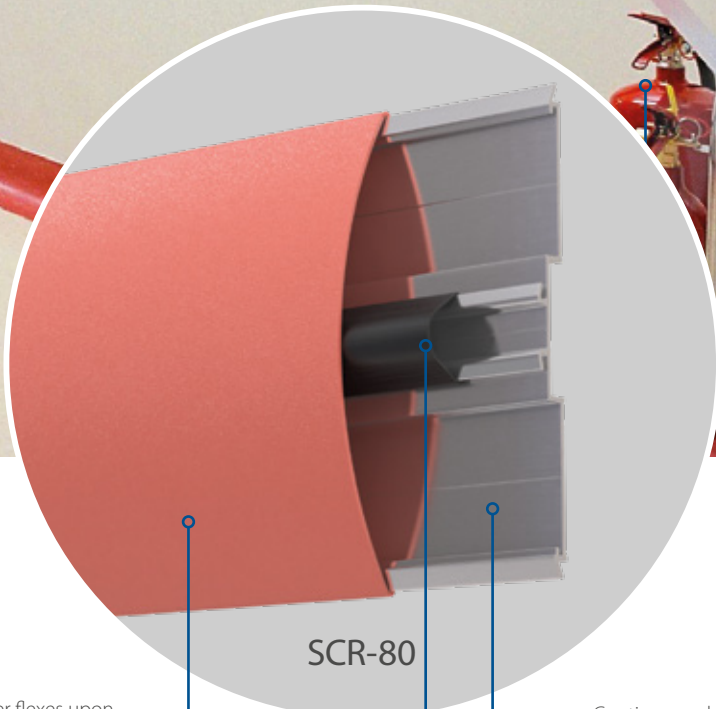

SCR-80

Acrovyn cover flexes upon impact and recovers to its original shape. Textured finish helps to minimise the appearance of scratches and abrasions.

Continuous aluminium retainer fitted with Acrovyn re-grind bumper cushion absorbs the impact energy and dissipates it along the crash rail's length.





# The Range



## SCR-80

● Acrovyn ● Acrovyn PVC-Free

**Height:** 203mm

**Duty Rating:** Heavy/Medium

**Page 96**



## SCR-50

● Acrovyn ● Acrovyn PVC-Free

**Height:** 127mm

**Duty Rating:** Heavy/Medium

**Page 97**



## SCR-170

● Acrovyn

**Height:** 170mm

**Duty Rating:** Heavy/Medium

**Page 98**



## SCR-200

● Acrovyn

**Height:** 203mm

**Duty Rating:** Heavy/Medium

**Page 99**

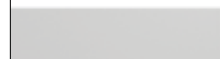

## HCR-200

● Acrovyn

**Height:** 203mm

**Duty Rating:** Severe

**Page 100**

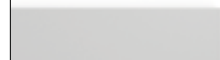

## SCR-150N

● Acrovyn PVC-Free

**Height:** 152mm

**Duty Rating:** Heavy/Medium

**Page 102**



## BG-10

● Acrovyn ● Acrovyn PVC-Free

**Height:** 102mm

**Duty Rating:** Medium

**Page 103**



## TP

● Acrovyn

**Height:** 300, 200, 150, 100mm

**Duty Rating:** Medium

**Page 104**

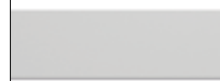

## FR-225

● Acrovyn ● Acrovyn PVC-Free

**Height:** 57mm

**Duty Rating:** Light

**Page 105**



# ACROVYN® SCR-80 Crash Rails

● Acrovyn ● Acrovyn PVC-Free

203mm high, curved profile crash rails offering a modern aesthetic and extensive impact protection for high traffic areas.



[www.c-sgroup.eu/384](http://www.c-sgroup.eu/384)

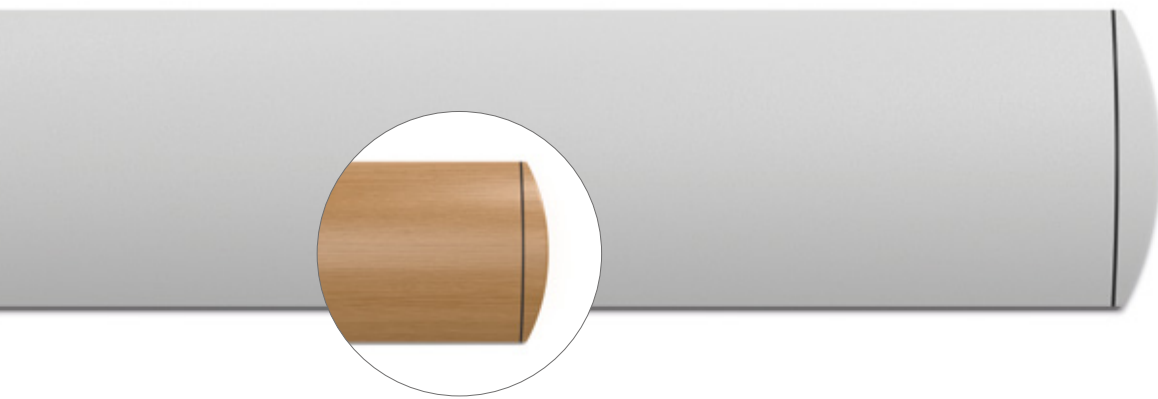

- Impact resistant, textured cover over continuous aluminium retainer as standard
- A version mounted on aluminium clips for areas requiring medium duty protection
- Free-floating cover and internal, continuous bumper cushion effectively absorb impact force
- Available in solid colours and contemporary finishes

## CONTINUOUS RETAINER HEAVY DUTY

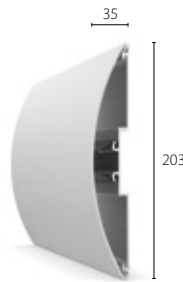

## MOUNTING CLIPS MEDIUM DUTY



## COLOURS & TEXTURE

Solid Colours: Acrovyn (27), Acrovyn PVC-Free (15)

Finishes: Acrovyn (12) - Woodgrains, Metals and Concretes

Texture: Shadowgrain

See Colour Foldout **pages 151-152**.

PRODUCT CODES	CONTINUOUS RETAINER	MOUNTING CLIPS
<b>Acrovyn</b>	SCR-80M	SCR-80
<b>Acrovyn PVC-Free</b>	SCR-80MN	SCR-80N

## ACCESSORIES

- End caps
- External corners
- Vertical accent trims (optional) - Black (standard) or Light Grey

## STOCK LENGTHS & FIXINGS

- Acrovyn - 4.0m;  
Acrovyn PVC-Free - 3.0m
- Fix at max 600mm centres; aluminium clips at max 600mm centres.

ACROVYN®

● Acrovyn ● Acrovyn PVC-Free

# SCR-50 Crash Rails

127mm high, curved profile crash rails offering reliable protection for areas prone to impact damage.



Heavy/Medium Duty



[www.c-sgroup.eu/387](http://www.c-sgroup.eu/387)



- Impact resistant, textured cover over continuous aluminium retainer as standard
- A version mounted on aluminium clips for areas requiring medium duty protection
- Free-floating cover and internal, continuous bumper cushion effectively absorb impact force

## CONTINUOUS RETAINER HEAVY DUTY

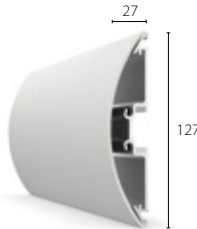

## MOUNTING CLIPS MEDIUM DUTY

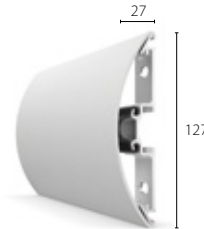

## COLOURS & TEXTURE



Solid Colours: Acrovyn (27),  
Acrovyn PVC-Free (15)



Texture: Shadowgrain

See Colour Foldout **pages 151-152**.

PRODUCT CODES	CONTINUOUS RETAINER	MOUNTING CLIPS
Acrovyn	SCR-50M	SCR-50
Acrovyn PVC-Free	SCR-50MN	SCR-50N

## ACCESSORIES

- End caps
- External corners
- Vertical accent trims (optional) - Black (standard) or Light Grey

## STOCK LENGTHS & FIXINGS

- Acrovyn - 4.0m;  
Acrovyn PVC-Free - 3.0m
- Fix at max 600mm centres;  
aluminium clips at max 600mm centres.

# ACROVYN®

## SCR-170 Crash Rails

● Acrovyn

170mm high, curved profile crash rails with smooth cover, offering essential impact protection in hygiene sensitive areas.



Heavy/Medium Duty

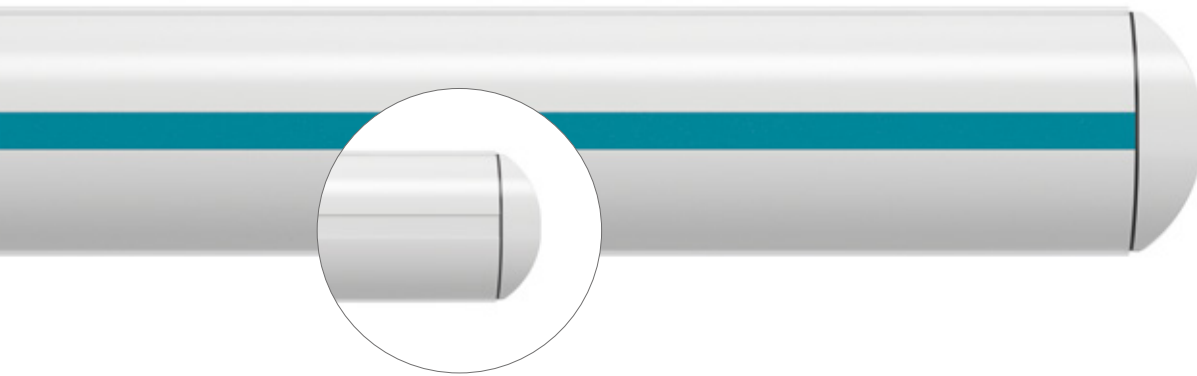

Dual Colour

[www.c-sgroup.eu/6867](http://www.c-sgroup.eu/6867)

- Impact resistant, smooth cover over continuous bumper cushion and aluminium mounting clips as standard
- A version mounted on aluminium clips for areas requiring medium duty protection
- Flexible top/bottom edge seals for a hygienic finish
- Optional decorative insert can be used to add style or create wayfinding schemes

### CONTINUOUS BUMPER & MOUNTING CLIPS

HEAVY DUTY

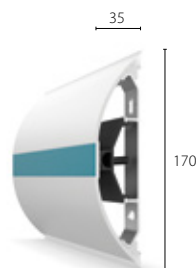

SCR-170

### MOUNTING CLIPS

MEDIUM DUTY

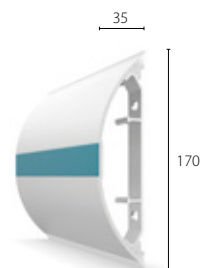

SCR-170E

### COLOURS & TEXTURE



**Solid Colours:** cover (27), optional insert (36)



**Texture:** cover - Smooth; optional insert - Suede

See Colour Foldout **pages 150** (insert) **and 152** (cover).

### ACCESSORIES

- End caps
- External corners
- Vertical accent trims (optional) - Black (standard) or Light Grey
- Decorative insert (optional)

### STOCK LENGTHS & FIXINGS

- Acrovyn - 4.0m
- Aluminium clips at max 600mm centres.

ACROVYN®

● Acrovyn

# SCR-200 Crash Rails

203mm high, classic flat style crash rails designed to prevent wall damage in busy facilities.



Heavy/Medium Duty



[www.c-sgroup.eu/2524](http://www.c-sgroup.eu/2524)



- Impact resistant, textured cover over continuous aluminium retainer as standard
- A version mounted on aluminium clips for areas requiring medium duty protection
- Free-floating cover and two internal, continuous bumper cushions absorb impact force

## CONTINUOUS RETAINER

HEAVY DUTY

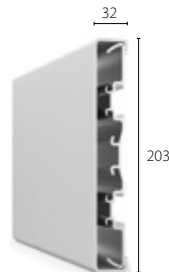

SCR-200M

## MOUNTING CLIPS

MEDIUM DUTY

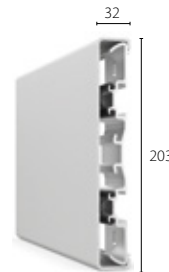

SCR-200

## COLOURS & TEXTURE



Solid Colours: Acrovyn (27)



Texture: Shadowgrain

See Colour Foldout **page 152**.

## ACCESSORIES

- End caps
- External corners

## STOCK LENGTHS & FIXINGS

- Acrovyn - 4.0m
- Fix at max 600mm centres; aluminium clips at max 600mm centres.

# ACROVYN®

## HCR-200 Crash Rails

● Acrovyn

203mm high, classic flat style crash rails for areas prone to extensive damage from heavily laden trolleys and other equipment.



Quick Lock



Severe Duty

[www.c-sgroup.eu/2534](http://www.c-sgroup.eu/2534)

- Impact resistant, textured cover over continuous aluminium retainer
- Free-floating cover design and three internal, continuous bumper cushions absorb impact force
- Mounted on Quick Lock brackets for ease of installation and maintenance
- Return to wall end caps for additional protection

### QUICK LOCK

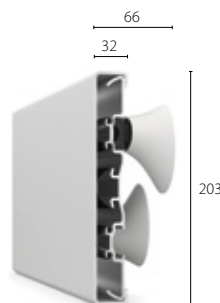

HCR-200

### COLOURS & TEXTURE



Solid Colours: Acrovyn (27)



Texture: Shadowgrain

See Colour Foldout **page 152**.

### ACCESSORIES

- End caps
- External corners
- Quick Lock brackets

### STOCK LENGTHS & FIXINGS

- Acrovyn - 4.0m
- Staggered fixings at max 600mm centres. Fixing into studwork or pattresses recommended.



# ACROVYN®

## SCR-150N Crash Rails

● Acrovyn PVC-Free

152mm high, classic flat profile crash rails offering effective protection for areas vulnerable to damage.



Heavy/Medium Duty



[www.c-sgroup.eu/389](http://www.c-sgroup.eu/389)



- Impact resistant, textured cover over continuous aluminium retainer as standard
- A version mounted on aluminium clips for areas requiring medium duty protection
- Free-floating cover design and a continuous, internal bumper cushion for effective impact protection

### CONTINUOUS RETAINER

HEAVY DUTY

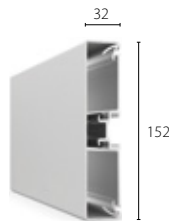

SCR-150MN

### MOUNTING CLIPS

MEDIUM DUTY

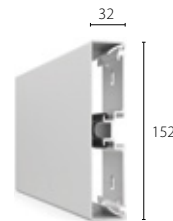

SCR-150N

### COLOURS & TEXTURE



**Solid Colours:** Acrovyn PVC-Free (15)



**Texture:** Shadowgrain

See Colour Foldout **page 152**.

### ACCESSORIES

- End caps
- External corners

### STOCK LENGTHS & FIXINGS

- Acrovyn PVC-Free - 3.0m
- Fix at max 600mm centres; aluminium clips at max 600mm centres.



ACROVYN®

● Acrovyn ● Acrovyn PVC-Free

# BG-10 Bumper Guards

102mm high, bullnose style bumper guard designed to keep wheeled equipment away from the wall. Often used at low level in combination with handrails or other crash rails.



 [www.c-sgroup.eu/2535](http://www.c-sgroup.eu/2535)



- Acrovyn cover over continuous aluminium retainer
- Large bullnose profile flexes for maximum bumper action protection
- Mounted on spacers for extra stand-off from the wall

## SPACER MOUNTED

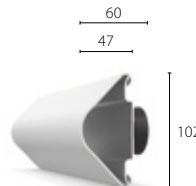

PRODUCT CODES	SPACER MOUNTED
Acrovyn	BG-10
Acrovyn PVC-Free	BG-10N

## COLOURS & TEXTURE



Solid Colours: Acrovyn (27),  
Acrovyn PVC-Free (15)



Texture: Shadowgrain

See Colour Foldout **page 152**.

## ACCESSORIES

- End caps
- External corners

## STOCK LENGTHS & FIXINGS

- Acrovyn - 4.0m;  
Acrovyn PVC-Free - 3.0m
- Fix at max 600mm centres.

# ACROVYN®

## TP Rub Rails

 Acrovyn

A range of easy to install rub rails protecting walls from scuffs, scratches and abrasions caused by pedestrian traffic, chairs or lightweight trolleys.



Medium Duty

[www.c-sgroup.eu/390](http://www.c-sgroup.eu/390)

- 3mm thick, textured and through-coloured rub rails
- Bullnose edges to mould profile to the wall
- Four heights to suit project requirements
- Simple installation using tape or adhesive

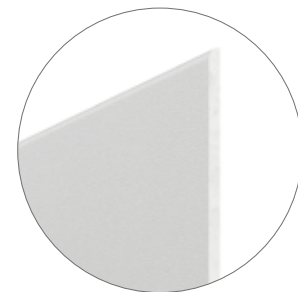
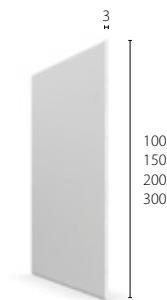

Bullnose top and bottom edge to mould profile to the wall

### COLOURS & TEXTURE



Solid Colours: All Acrovyn Sheet Colours (36)



Texture: Shadowgrain

See Colour Foldout **page 150**.

PRODUCT CODES	100MM HIGH	150MM HIGH	200MM HIGH	300MM HIGH
Acrovyn	TP-100	TP-150	TP-200	TP-300

### ACCESSORIES

- Preformed internal or external corners can be supplied to order
- Adhesive foam tape (can be factory applied if required)
- Construction adhesive

### STOCK LENGTHS & FIXINGS

- Acrovyn - 4.0m
- Installation using adhesive foam tape and construction adhesive

ACROVYN®

● Acrovyn ● Acrovyn PVC-Free

# FR-225 Rub Rails

57mm high, crescent shaped, unobtrusive rub rails offering light duty protection for walls and doors.



Light Duty



[www.c-sgroup.eu/388](http://www.c-sgroup.eu/388)



- Acrovyn cover over continuous aluminium retainer
- Low profile crescent shape
- Free-floating cover design flexes on impact

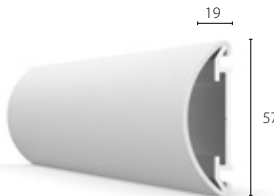

## COLOURS & TEXTURE



Solid Colours: Acrovyn (27),  
Acrovyn PVC-Free (15)



Texture: Shadowgrain

See Colour Foldout **page 152**.

## PRODUCT CODES

**Acrovyn**

**Acrovyn PVC-Free**

## SURFACE MOUNTED

FR-225

FR-225N

## ACCESSORIES

- End caps
- External corners
- Vertical accent trims (optional) -  
Black (standard) or Light Grey

## STOCK LENGTHS & FIXINGS

- Acrovyn - 4.0m  
Acrovyn PVC-Free - 3.0m
- Fix at max 600mm centres

# Acrovyn® Bed Head Protection

Bed Head Protectors are designed to protect walls or wall mounted equipment from damage at bed head locations.

They are typically used in healthcare facilities, where patient beds are frequently moved around or adjusted. Surface and bracket mounted options are available in a range of designs to suit all protection requirements.

Where a durable, wipe clean wall finish or personalisation of bedrooms is required, our solid colour sheet options or bespoke Acrovyn by Design panels will provide an attractive and long-lasting surface.

## APPLICATIONS:

- Healthcare wards, en-suite rooms and intensive care units
- Care homes
- Hotel bedrooms

 [www.c-sgroup.eu/2564](http://www.c-sgroup.eu/2564)



- 1 BL-10V Bed Head Protectors  
**Page 112**
- 2 Acrovyn by Design  
**Page 50**
- 3 BL-4C Bed Head Protectors  
**Page 113**



Durable Acrovyn by Design murals can be used to personalise bed spaces and create a healing environment.



BL-10V

Large bullnose profile flexes upon impact and recovers to its original shape. Textured finish helps to minimise the appearance of scratches and abrasions.

Continuous aluminium retainer adds strength, and mounting spacers keep profile off the wall.





# The Range

## BL-10H

● Acrovyn ● Acrovyn PVC-Free

**Type:** Horizontal, single

**Mounting:** Spacers or extended brackets

**Duty Rating:** Medium

**Page 110**



## BL-40V

● Acrovyn Bactericide

**Type:** Vertical, pair

**Mounting:** Extended brackets

**Duty Rating:** Medium

**Page 111**



## BL-10V

● Acrovyn ● Acrovyn PVC-Free

**Type:** Vertical, pair

**Mounting:** Spacers or extended brackets

**Duty Rating:** Medium

**Page 112**



## BL-4C

● Acrovyn ● Acrovyn PVC-Free

**Type:** Vertical, pair

**Mounting:** Quick Lock or extended brackets

**Duty Rating:** Severe

**Page 113**



## Flat Bed Head Protection

**Type:** Impact resistant Sheet, solid colours and bespoke designs

**Mounting:** Adhesive

**Page 114**



 [www.c-sgroup.eu/2564](http://www.c-sgroup.eu/2564)

ACROVYN®

● Acrovyn ● Acrovyn PVC-Free

# BL-10H Bed Head Protectors

Horizontal bed head protectors designed to prevent damage to wall and wall mounted equipment from frequently moved beds.



Medium Duty

[www.c-sgroup.eu/2565](http://www.c-sgroup.eu/2565)



- Impact resistant, textured cover over continuous aluminium retainer
- Shock absorbing cover flexes on impact
- Mounted on spacers or custom length, powder coated aluminium brackets
- Supplied as kits for ease of installation

## COLOURS & TEXTURE

Solid Colours: Acrovyn (27)  
Acrovyn PVC-Free (15)

Texture: Shadowgrain

See Colour Foldout **page 152**.

## SPACER MOUNT

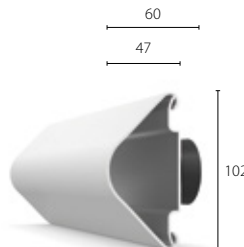

## EXTENDED BRACKET

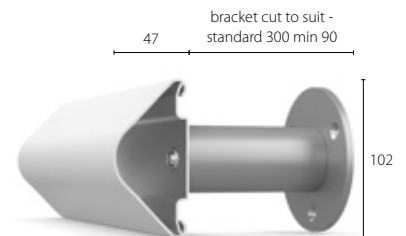

PRODUCT CODES	SPACER MOUNT	EXTENDED BRACKET
<b>Acrovyn</b>	BL-10H	BL-10HE
<b>Acrovyn PVC-Free</b>	BL-10HN	BL-10HEN

## ACCESSORIES

- Supplied pre-cut with end caps and mounting accessories included

## STOCK LENGTHS & FIXINGS

- Rail: 1100mm standard (inc. end caps); 1600mm max.  
**Extended brackets:** 300mm long, or cut to suit (min. 90mm)
- Fix at max 400mm centres; fixing to studwork or pattresses recommended, particularly for bracket variants



ACROVYN®

● Acrovyn Bactericide

# BL-40V Bed Head Protectors

Pairs of circular, vertical bed head protectors designed to protect walls from damage caused by frequently moved or height adjusted beds.



Medium Duty



Bactericide Certified



[www.c-sgroup.eu/8515](http://www.c-sgroup.eu/8515)



- A pair of tubular 40mm Ø unobtrusive bed head protectors
- Smooth cover with added bactericide, ideal for hygienic environments (tested to ISO 22196 see **page 10**)
- Continuous aluminium retainer for strength
- Mounted on stainless steel brackets
- Supplied as kits for ease of installation

## BRACKET MOUNT



BL-40V

## COLOURS & TEXTURE



Solid Colours: Acrovyn (27)



Texture: Smooth

See Colour Foldout **page 152**.

## STOCK LENGTHS & FIXINGS

- 700mm standard (inc. end stops); stainless steel brackets to provide 104mm overall projection from the wall
- Fix at max 500mm vertical centres; fixing to studwork or pattresses recommended

## ACCESSORIES

- Supplied pre-cut with end stops and brackets included
- Horizontal accent trims (optional) - Black (standard) or Light Grey

# ACROVYN® BL-10V Bed Head Protectors

● Acrovyn ● Acrovyn PVC-Free

Pairs of vertical bed head protectors for applications where beds are often moved around and their heights frequently adjusted.



Medium Duty

[www.c-sgroup.eu/2568](http://www.c-sgroup.eu/2568)

- Impact resistant, textured cover over continuous aluminium retainer
- Shock absorbing cover flexes on impact
- Mounted on spacers or custom length, powder coated aluminium brackets
- Supplied as kits for ease of installation

## SPACER MOUNT

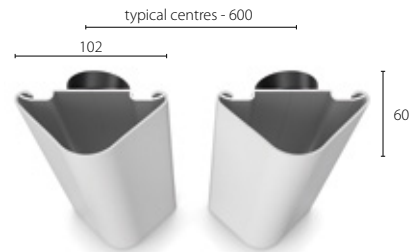

## EXTENDED BRACKET

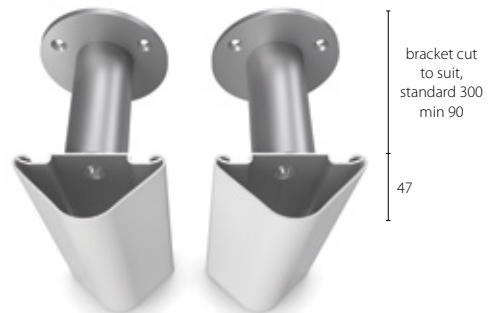

PRODUCT CODES	SPACER MOUNT	EXTENDED BRACKET
Acrovyn	BL-10V	BL-10VE
Acrovyn PVC-Free	BL-10VN	BL-10VEN

## COLOURS & TEXTURE



Solid Colours: Acrovyn (27)  
Acrovyn PVC-Free (15)



Texture: Shadowgrain

See Colour Foldout **page 152**.

## ACCESSORIES

- Supplied pre-cut with end caps and mounting accessories included

## STOCK LENGTHS & FIXINGS

- 700mm standard (inc. end caps); extended brackets 300mm long, or cut to suit (min. 90mm)
- Fix at max 400mm vertical centres. Fixing to studwork or pattresses recommended, particularly for extended bracket variants

ACROVYN®

● Acrovyn ● Acrovyn PVC-Free

# BL-4C Bed Head Protectors

Pairs of vertical bed head protectors offering severe duty protection to walls and wall mounted equipment from damage caused by frequently moved beds.



Quick Lock



Severe Duty



[www.c-sgroup.eu/2571](http://www.c-sgroup.eu/2571)



- Impact resistant, textured cover over continuous aluminium retainer
- Free-floating cover and internal, continuous bumper cushion for effective impact protection
- Mounted on Quick Lock brackets or custom length, powder coated aluminium brackets
- Infill strip closes off retainer channel for ease of cleaning
- Supplied as kits for ease of installation

## QUICK LOCK

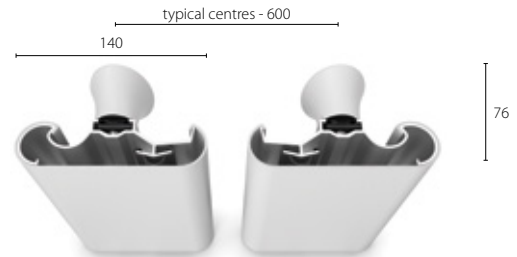

## EXTENDED BRACKET



PRODUCT CODES	QUICK LOCK	EXTENDED BRACKET
Acrovyn	BL-4C	BL-4CE
Acrovyn PVC-Free	BL-4CN	BL-4CEN

## COLOURS & TEXTURE



Solid Colours: Acrovyn (27)  
Acrovyn PVC-Free (15)



Texture: Shadowgrain

See Colour Foldout **page 152**.

## ACCESSORIES

- Supplied pre-cut with end caps and brackets included
- Horizontal accent trims (optional) - Black (standard) or Light Grey

## STOCK LENGTHS & FIXINGS

- 700mm standard (inc. end caps); extended brackets 300mm long, or cut to suit (min. 90mm)
- Fix at max 350mm vertical centres; Fixing to studwork or pattresses recommended, particularly for extended bracket variants

ACROVYN®

● Acrovyn ● Acrovyn PVC-Free

# Flat Bed Head Protection

Acrovyn Sheet or Acrovyn by Design can be installed behind beds to provide a bespoke, decorative and protective wall finish.



Medium Duty

[www.c-sgroup.eu/16633](http://www.c-sgroup.eu/16633)

- Used on projects where personalised or a more domestic look is required
- Can be used in combination with other bed head protectors
- Available in a wide range of colours and finishes, or can incorporate bespoke artwork
- Sizes to suit project requirements
- Economical and easy to install

## ACROVYN SHEET - ACROVYN PVC-FREE SHEET



## COLOURS & TEXTURE



Solid Colours:

Acrovyn Sheet (36)  
Acrovyn PVC-Free Sheet (36)



Finishes: Acrovyn Sheet (12)  
- Woodgrains, Metals and  
Concretes



Acrovyn by Design: Bespoke  
imagery or colours



Texture: Suede or Smooth  
(select Acrovyn colours)

## ACROVYN BY DESIGN - BESPOKE IMAGERY OR COLOURS

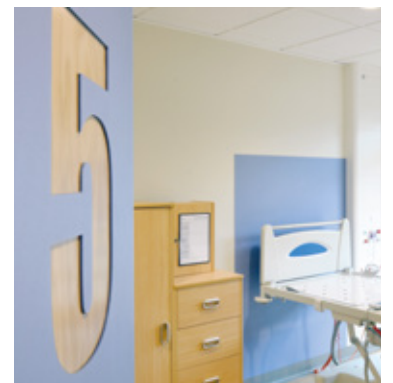

See Colour Foldout **pages 150 -151**.



# Stainless Steel Protection

Our stainless steel models offer a sleek, smooth appearance and robust protection for hotel, commercial and retail environments.

As they are inherently hygienic, they're also suitable for areas where cleanliness is of paramount importance.

The range includes options for protecting walls, corners, glazing and other building features.

## APPLICATIONS:

- Kitchens and food serving areas
- Laboratories
- Pharmaceutical manufacturing
- Food manufacturing
- Retail areas
- Corridors with regular wheeled traffic
- Back-of-house areas

 [www.c-sgroup.eu/16686](http://www.c-sgroup.eu/16686)



- 1 Floor Mounted LLRSS  
Page 122
- 2 CRC-150  
Page 120



Tubular rail system manufactured from highly durable 304L Grade stainless steel

LLRSS

Robust brackets for floor or wall mounting

Stainless steel end caps or end stops can be specified to suit project needs







# The Range

## CRC-150

● Stainless Steel



**Height:** 150mm

**Duty Rating:** Heavy

**Page 120**

## CRS

● Stainless Steel



**Height:** 100, 150, 200mm

**Duty Rating:** Heavy

**Page 121**

## LLRSS

● Stainless Steel



**Height:** 178mm

**Duty Rating:** Severe

**Page 122**



## PP-76

● Stainless Steel

**Height:** 900mm

**Duty Rating:** Severe

**Page 123**



## Stainless Steel Corner Guards

● Stainless Steel

**Leg:** 30, 50, 75mm

**Duty Rating:** Heavy

**Page 124**

## Also available:

## HRS-6

● Stainless Steel



**Size:** 40mm Ø Handrail

**Brackets:** Stainless steel

**Page 79**

## Stainless Steel Sheet

● Stainless Steel



**Thickness:** 1mm

**Size:** 2500 x 1250mm

**Page 44**

 [www.c-sgroup.eu/16686](http://www.c-sgroup.eu/16686)

# ACROVYN®

## CRC-150 Crash Rails

● Stainless Steel

150mm high, robust stainless steel crash rails in a curved profile, suitable for ultra-clean environments.

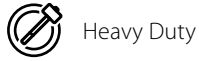

Heavy Duty



[www.c-sgroup.eu/394](http://www.c-sgroup.eu/394)



- Stainless steel cover in a brushed finish
- End caps pre-welded to surveyed rail lengths for ease of installation
- Mounted over a continuous aluminium retainer for added strength

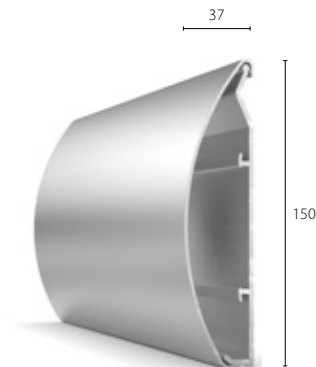

CRC-150

### COLOURS & TEXTURE

● **Material:** Grade 304L  
Stainless Steel

● **Finish:** Brushed

### ACCESSORIES

- End caps pre-welded to surveyed rail lengths

### STOCK LENGTHS & FIXINGS

- Lengths to cutting schedule from stock lengths of max 3.0m
- Fix at max. 400mm centres

ACROVYN®

● Stainless Steel

# CRS Series Crash Rails

A range of stainless steel crash rails in a classic profile offering high durability and impact protection.



[www.c-sgroup.eu/6869](http://www.c-sgroup.eu/6869)



- Stainless steel cover in a brushed finish
- Available in three heights to suit project requirements
- End caps pre-welded to surveyed rail lengths for ease of installation
- Mounted using pre-drilled continuous stainless steel clips

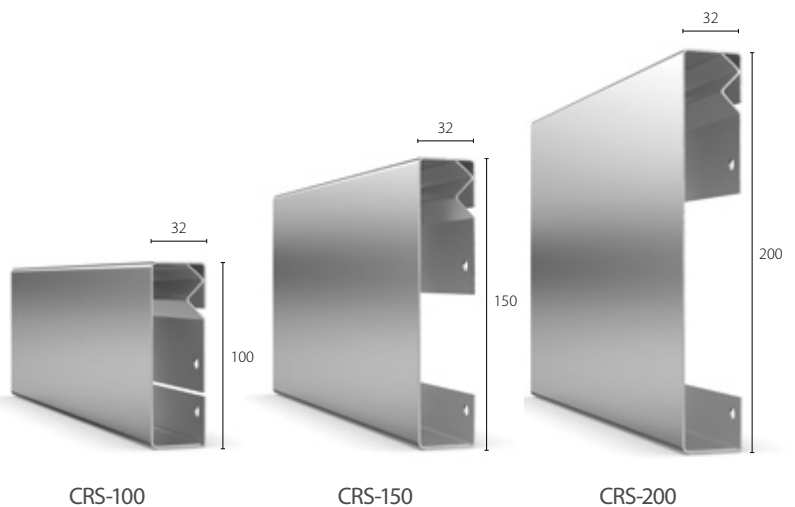

## COLOURS & TEXTURE

- **Material:** Grade 304L Stainless Steel
- **Finish:** Brushed

## ACCESSORIES

- End caps pre-welded to surveyed rail lengths
- Supplied complete with top and bottom stainless steel clips

## STOCK LENGTHS & FIXINGS

- Lengths to cutting schedule from stock lengths of max 3.0m
- Continuous fixing clips supplied pre-drilled in lengths to suit profile sizes

ACROVYN®

● Stainless Steel

# LLRSS Low Level Crash Rails

Severe duty, stainless steel rails, ideal for protecting fully glazed corridor walls and other interior features.

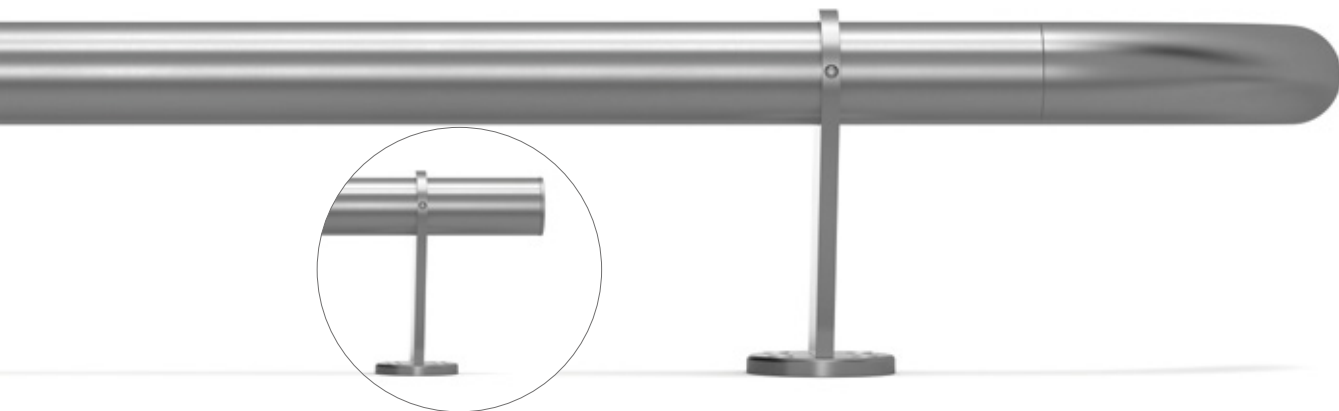

Severe Duty

[www.c-sgroup.eu/395](http://www.c-sgroup.eu/395)

- 51mm ø stainless steel tubular rail
- Mounted on robust stainless steel brackets for extra stability
- Suitable for floor or wall mounting
- Radiused sections can be supplied to be fitted around columns and other features (min 600mm radius)

## FLOOR MOUNTED

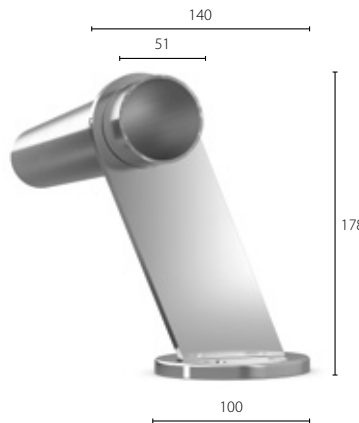

## WALL MOUNTED

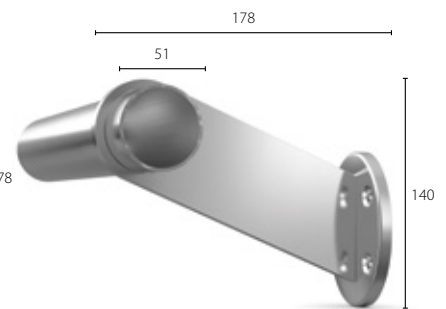

## COLOURS & TEXTURE

● **Material:** Grade 304L  
Stainless Steel

● **Finish:** Brushed

## ACCESSORIES

- End caps
- End stops
- Internal / external corners
- Brackets for floor / wall mounting

## STOCK LENGTHS & FIXINGS

- Rail: 3.0m
- Brackets at max. 1000mm centres

ACROVYN®

● Stainless Steel

## PP-76 Posts

Severe duty, stainless steel posts designed to protect architectural features, corners and doors by deflecting wheeled traffic away.



Severe Duty



[www.c-sgroup.eu/2543](http://www.c-sgroup.eu/2543)

- Robust stainless steel posts designed for floor mounting
- Supplied with base plate cover to conceal fixings for a neat finish
- Available in a range of heights to suit application (900mm as standard)
- Complete with domed stainless steel cap

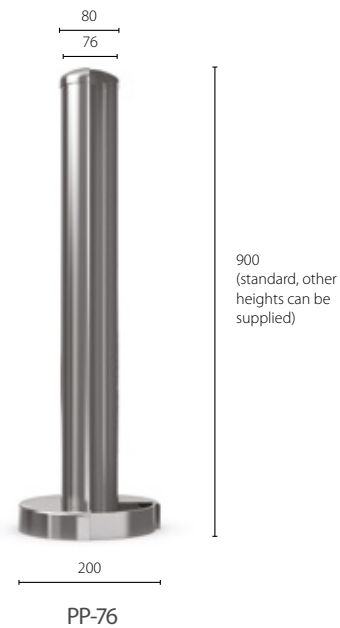

### COLOURS & TEXTURE



Material: Grade 304L  
Stainless Steel



Finish: Brushed

### STOCK LENGTHS & FIXINGS

- 900mm high as standard, other heights can be supplied if required

# ACROVYN® Stainless Steel Corner Guards

● Stainless Steel

Surface mounted stainless steel corner guards offering heavy duty protection to vulnerable external corners.



Heavy Duty

 [www.c-sgroup.eu/8505](http://www.c-sgroup.eu/8505)



- Manufactured from 1mm thick stainless steel
- Cranked edges provide a slight void behind corner guards to accommodate wall irregularities
- Available in three leg sizes to suit project requirements
- Designed to suit 90° corners as standard. Custom angles can be supplied on request.
- Installed using construction adhesive or can be mechanically fastened



## 90° CORNERS\*



\* Custom angles can be supplied on request

	90° CORNERS		
	30MM LEG	50MM LEG	75MM LEG
Stainless Steel	30A	50A	75A

## COLOURS & TEXTURE

-  Material: Grade 304L Stainless Steel
-  Finish: Brushed

## STOCK LENGTHS & FIXINGS

- Lengths: 3.0m
- Installation using construction adhesive (can be supplied if required) or mechanical fasteners



# EPDM Rubber Protection

Our EPDM rubber wall protection range has excellent shock-absorbing and weather resistant qualities and is ideal for protecting back of house, manufacturing and delivery areas from damage caused by vehicular traffic, trolleys and carts.

Robust EPDM profiles are suitable for both interior and exterior environments and can be fixed directly to concrete, steel, masonry or timber.

## APPLICATIONS:

- Service corridors
- Back of house areas
- Loading bays
- Baggage re-claim
- Warehouses
- Car parks

 [www.c-sgroup.eu/16687](http://www.c-sgroup.eu/16687)



- 1 200W50 with optional hazard tape  
**Page 130**
- 2 100C  
**Page 134**
- 3 200W30  
**Page 130**
- 4 75C  
**Page 134**





Manufactured from EPDM Rubber for excellent resistance to UV and weathering. Suitable for both interior and exterior applications.

Robust crash rail design to offer severe duty protection in heavily abused areas.

200W50

Optional self adhesive hazard tape (white reflective tape also available).





# The Range

## 200W

● EPDM Rubber



**Height:** 200mm

**Duty Rating:** Severe

**See page 130**

## 150W20

● EPDM Rubber



**Height:** 150mm

**Duty Rating:** Severe

**See page 131**

## D-Section

● EPDM Rubber



**Height:** 75, 100mm

**Duty Rating:** Severe

**See page 132**

## 60B

● EPDM Rubber



**Height:** 60mm

**Duty Rating:** Heavy

**See page 133**



## EPDM Rubber Corner Guards

● EPDM Rubber

**Leg:** 75, 100mm

**Duty Rating:** Severe

**See page 134**

 [www.c-sgroup.eu/16687](http://www.c-sgroup.eu/16687)

# ACROVYN®

## 200W Crash Rails

● EPDM Rubber

200mm high, severe duty EPDM rubber crash rails, capable of withstanding the toughest knocks in back of house, delivery and car park areas.

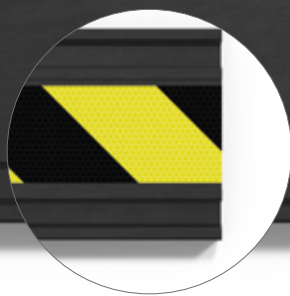

Severe Duty

[www.c-sgroup.eu/406](http://www.c-sgroup.eu/406)

- EPDM rubber crash rails available in two thicknesses to suit project requirements
- Suitable for interior and exterior applications
- Optional light reflective or hazard tapes
- Can be fixed to circular columns using steel binding
- External and internal corners can be achieved through on-site mitering

### SURFACE MOUNTED



200W30



200W50

### MATERIAL

Black EPDM Rubber

### ACCESSORIES

- Optional light reflective, self adhesive inserts - White or Yellow/Black



### STOCK LENGTHS & FIXINGS

- Lengths: 3.0m
- Fix at max. 300mm staggered centres

ACROVYN®

● EPDM Rubber

# 150W20 Crash Rails

150mm high, slimline EPDM rubber crash rails used for protecting walls from damage caused by trolleys, carts and vehicles.



Severe Duty



[www.c-sgroup.eu/407](http://www.c-sgroup.eu/407)



- Severe duty EPDM rubber crash rails
- Suitable for interior and exterior applications
- Snap-in cover strip conceals fixings for a neat finish
- Supplied with internal aluminium strip for firm wall fastening
- External and internal corners can be achieved through on-site mitering

## SURFACE MOUNTED



150W20

## MATERIAL



Black EPDM Rubber

## STOCK LENGTHS & FIXINGS

- Lengths: 3.0m
- Fixing: Fix at max. 400mm centres

ACROVYN®

● EPDM Rubber

# D-Section Crash Rails

75mm or 100mm high, D-section rubber crash rails offering severe duty impact protection for interior and exterior areas.



Severe Duty

[www.c-sgroup.eu/408](http://www.c-sgroup.eu/408)

- Severe duty EPDM rubber crash rails
- Available in two sizes to suit project requirements
- Suitable for interior and exterior applications
- Hollow design flexes under impact, absorbing its force
- Optional rubber end plugs and bolt bung covers available
- External and internal corners can be achieved through on-site mitering

## MATERIAL



Black EPDM Rubber

## SURFACE MOUNTED

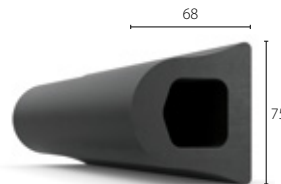

75D

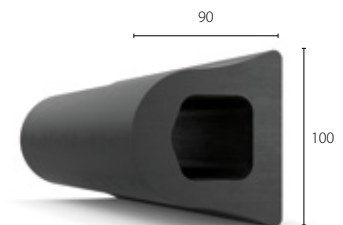

100D

## ACCESSORIES

- End plugs
- Bolt bung covers

## STOCK LENGTHS & FIXINGS

- Lengths: 3.0m
- Fix at max. 400mm centres. Sections require drilling on site, or can be supplied pre-drilled to special order

# ACROVYN®

## 60B Guards

● EPDM Rubber

60mm high, discreet B-section rubber guards offering heavy duty protection for vulnerable back of house areas.



[www.c-sgroup.eu/410](http://www.c-sgroup.eu/410)

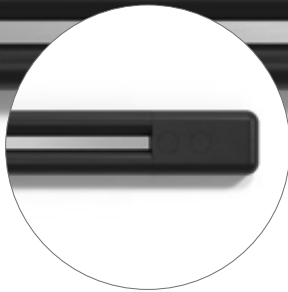

- Heavy duty EPDM rubber guards
- Continuous aluminium fixing strip for firm fixing to the wall
- Suitable for interior and exterior applications
- External and internal corners can be achieved through on-site mitering

### SURFACE MOUNTED

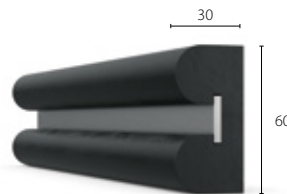

60B

### MATERIAL

● Black EPDM Rubber

### ACCESSORIES

- End caps

### STOCK LENGTHS & FIXINGS

- Lengths: 3.0m
- Fix at max. 400mm centres

ACROVYN®

● EPDM Rubber

# EPDM Rubber Corner Guards

75mm or 100mm leg, robust corner guards offering excellent corner protection for interior and exterior areas.



Severe Duty



[www.c-sgroup.eu/411](http://www.c-sgroup.eu/411)

- Severe duty, EPDM rubber corner guards
- Available in two sizes to suit project requirements
- Suitable for interior and exterior applications
- Installation using construction adhesive and/or proprietary fastenings
- 100C model is grooved on the internal surface to afford greater adhesion

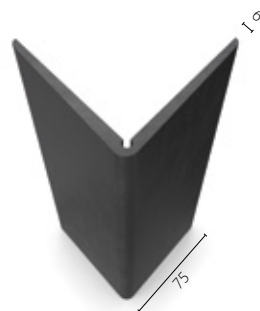
## SURFACE MOUNTED

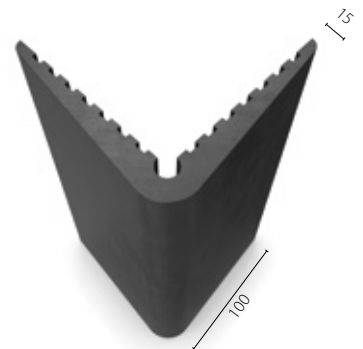

75C



100C

## MATERIAL



Black EPDM Rubber

## STOCK LENGTHS & FIXINGS

- Lengths: 3.0m
- Mechanical fixing at max. 300mm staggered centres, or construction adhesive



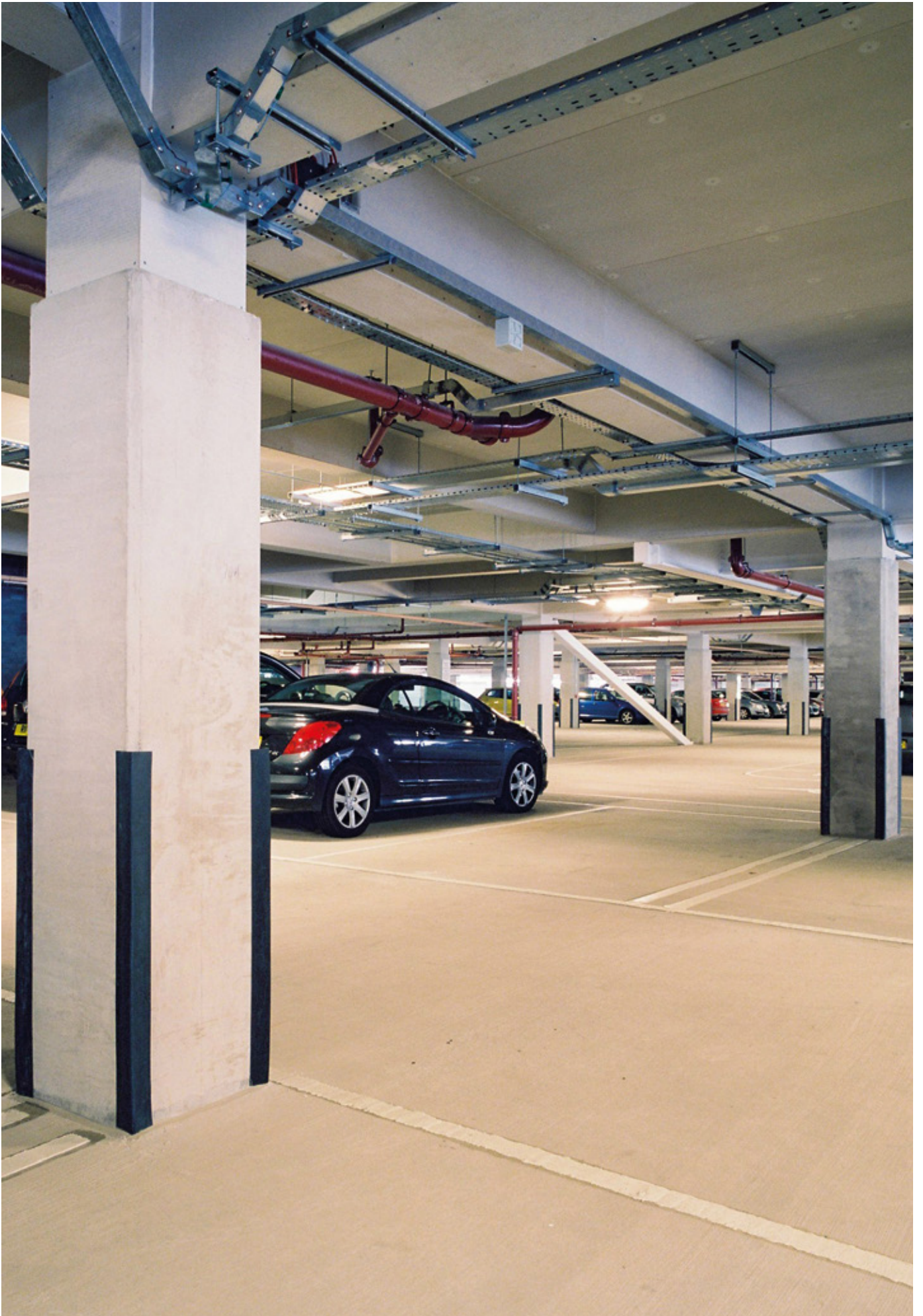

# Acrovyn® Door Protection

Doors and door frames are two building components most vulnerable to damage, and will often require periodic maintenance or replacement throughout the life of the building.

Wood veneer or high pressure laminate just can't handle the same abuse as durable Acrovyn. Our impact-resistant Acrovyn Sheet has been protecting doors in thousands of facilities worldwide, saving money in maintenance and costly repairs.

Built up from plates and/or formed sections, our door protection solutions can accommodate different door and door frame styles and sizes.

The product is available in a wide range of solid colours, woodgrain, metal and concrete finishes, or with Acrovyn by Design to make your door protection completely bespoke.

## APPLICATIONS:

- High traffic interior environments in a wide range of sectors from healthcare and education to retail and airports
- New and refurbished doors



 [www.c-sgroup.eu/16726](http://www.c-sgroup.eu/16726)



- 1 Half Moon push plate in 2mm Acrovyn Sheet  
**Page 142**
- 2 Half height door protection in 2mm Acrovyn Sheet, Wave design  
**Page 142**
- 3 TP-200 Rub Rail  
**Page 104**
- 4 Full height Door Cladding in 2mm Acrovyn Sheet  
**Page 140**
- 5 Door Frame Protection in 2mm Acrovyn Sheet  
**Page 145**



**SUITABLE FOR NEW DOORS AND REFURBISHMENT OF EXISTING DOORS**

**KEY BENEFITS**

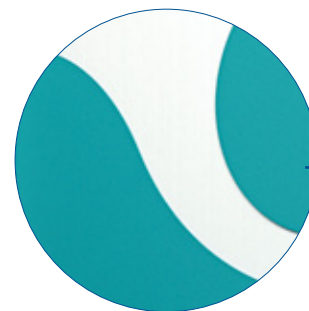

**Hygiene** - prevents dents, cracks and scratches which are ideal breeding ground for bacteria

**Maintenance** - eliminates or reduces the need for premature replacement or repair, protecting budgets

**Appearance** - prevents deterioration of door surfaces over its life cycle





# The Range

## Door Cladding



● Acrovyn ● Acrovyn PVC-Free

**Colours:** 36 solid,  
12 finishes

**Page 140**

## Door Face Protection



● Acrovyn ● Acrovyn PVC-Free

**Colours:** 36 solid,  
12 finishes, Acrovyn by  
Design

**Page 142**



## Door Edge Protectors



● Acrovyn

**Colours:** 36 solid,  
12 finishes

**Page 144**

## Door Frame Protection



● Acrovyn ● Acrovyn PVC-Free

**Colours:** 36 solid,  
12 finishes

**Page 145**

 [www.c-sgroup.eu/16726](http://www.c-sgroup.eu/16726)

# ACROVYN® Door Cladding

● Acrovyn ● Acrovyn PVC-Free



Bespoke manufactured Acrovyn Door Cladding creates a highly durable finish for extended life cycle and reduced maintenance costs.

 [www.c-sgroup.eu/2575](http://www.c-sgroup.eu/2575)

- Manufactured to custom specified sizes from 2mm Acrovyn Sheet or 1.5mm Acrovyn PVC-Free Sheet
- Full and part height solutions available.
- Plates and channels or formed angles are utilised to create a highly protective finish to door faces and edges.



## COLOURS & TEXTURE

 **Solid Colours:** Acrovyn (36),  
Acrovyn PVC-Free (36)

 **Finishes:** Acrovyn (12) -  
Woodgrains, Metals and  
Concretes

 **Texture:** Suede

See Colour Foldout **pages 150-151**.

## DOOR CLADDING OPTIONS

- Different configurations of plates, channels and angles can be used to achieve the required level of protection
- Full and part height solutions are available in any of our standard colours and finishes

### CHANNELS AND PLATES

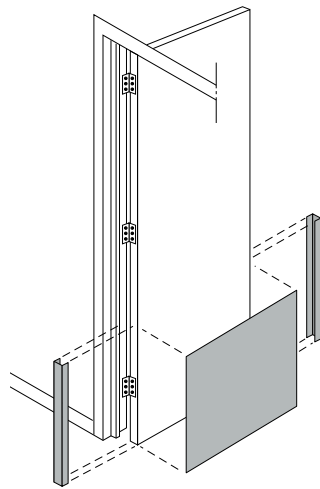

A combination of channels and plates for protection of door edges and face(s).

Plates are supplied with straight edges as standard. Bevelled edges (round or 45° bevel) can be requested.

*NOTE: Door edges may have to be rebated to allow for sheet thickness.*

### FORMED ANGLES

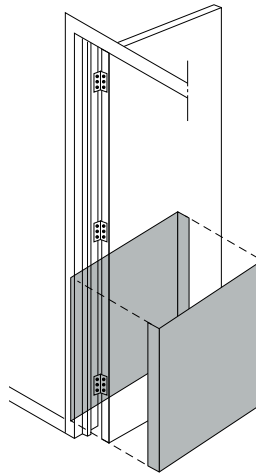

Large size formed angles for protection of door edges and faces.

*NOTE: Allowances have to be made for the thickness of sheet to ensure a good fit in the door frame. Rebating or adjusting is likely to be required, especially in part height applications.*

### APPLICATION IN WET AREAS

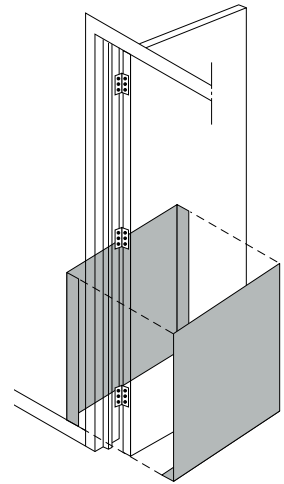

A solution for humid or wet environments consists of an angle and a channel to cover door faces and edges, including the bottom door edge.

*NOTE: A suitable, moisture resistant adhesive must be used, and any joints sealed to prevent moisture ingress.*

## DESIGN PROTECTION TO SUIT YOUR REQUIREMENTS



Part height protection, channels/plates or angles.



Half height plates and full height channels.



Full height protection, either channels/plates or formed angles.



Full height protection utilising decorative finishes for an attractive, natural look.

# ACROVYN®

## Door Face Protection

● Acrovyn ● Acrovyn PVC-Free



Simple, economical solution for protecting the most used and vulnerable areas of new or existing doors.

 [www.c-sgroup.eu/2577](http://www.c-sgroup.eu/2577)

- Manufactured to custom specified sizes from 2mm Acrovyn Sheet, 1.5mm Acrovyn PVC-Free Sheet or Acrovyn by Design.
- Plate edges are square as standard or can be bevelled to 45° or a radius on request
- Rectangular shapes and a selection of standard decorative designs are available
- Custom shapes can be easily accommodated

### KICK AND PUSH PLATES



Kick and push plates are ideal for protecting door faces of swing doors and the areas around the door handle / lock of any room door.

### PARTIAL PROTECTION



Most damage happens at the lower part of the door. Partial door face protection eliminates these problems while providing a decorative finish.

### FULL FACE PROTECTION



In areas where damage can be expected at any height of the door, or unified look of the door face is required, our full face protection provides a solution.

## COLOURS & TEXTURE



**Solid Colours:** Acrovyn (36), Acrovyn PVC-Free (36)



**Finishes:** Acrovyn (12) - Woodgrains, Metals and Concretes



**Acrovyn by Design:** Bespoke imagery



**Texture:** Suede

#### NOTE:

*Allowances need to be made to accommodate Acrovyn Sheet thickness in relation to the door frame to ensure a good fit.*

See Colour Foldout **pages 150-151**.



---

## STANDARD DESIGNS

---



01. RAINBOW



02. HALF MOON



03. LOCATE



04. RAINBOW WITH STRIP



05. DUNE



06. WAVE



07. INVERT



08. CITYSCAPE



09. OMBRE



10. VALLEY



CUSTOM DESIGN  
Incorporating  
Acrovyn by Design



CUSTOM DESIGN  
Custom cut sheet

# ACROVYN®

## Door Edge Protectors



Simple to install, robust and cost-effective solution for preventing damage to edges of new and existing timber core doors.

 [www.c-sgroup.eu/2579](http://www.c-sgroup.eu/2579)

- Made of 2mm Acrovyn, Door Edge Protectors incorporate 8mm thick inner Acrovyn lipping
- Can be fitted to one or both door edges and used in combination with door face protection if required
- Supplied with colour matched pellets to conceal fixings
- To suit 44mm or 54mm thick doors with radiused edges (other thicknesses can be accommodated\*)
- Standard height 2100mm (heights up to 2500mm can be manufactured)

to suit 44mm or 54mm door thicknesses as standard

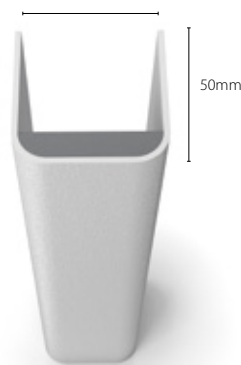

### INSTALLATION OPTIONS

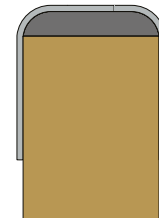

Door edge protector only

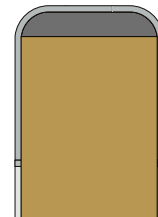

Installed flush with door face protection

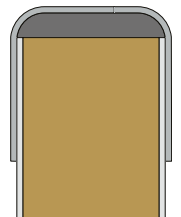

Overlapping door face protection

### COLOURS & TEXTURE



Solid Colours:  
Acrovyn (36)



Texture: Suede

See Colour Foldout **page 150**.

*\* Tooling charges may apply. Contact us to discuss your requirements.*

ACROVYN®

# Door Frame Protection



An effective protection solution for vulnerable timber or metal door frames and architraves.

 [www.c-sgroup.eu/2578](http://www.c-sgroup.eu/2578)

- Made to customer specified sizes from 2mm Acrovyn Sheet or 1.5mm Acrovyn PVC-Free Sheet
- Built up from a series of channel and angle sections to provide full frame or architrave protection
- Full or partial height protection can be supplied
- Channels can be supplied to suit square or rounded edge sections\*

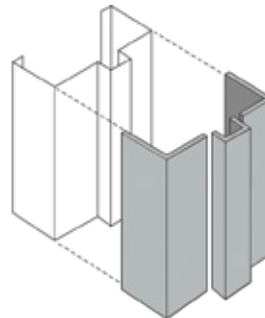

*Note: Sheet thickness should be taken into account in calculation of sizes. We will require internal dimensions of the frame protection required.*

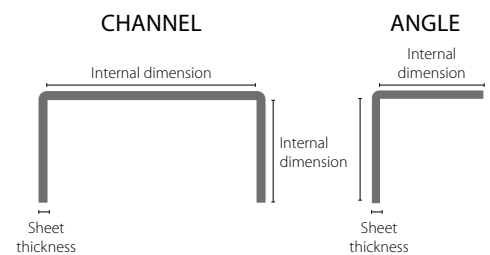

## COLOURS & TEXTURE

 **Solid Colours:** Acrovyn (36), Acrovyn PVC-Free (36)

 **Finishes:** Acrovyn (12) - Woodgrains, Metals and Concretes

 **Texture:** Suede

See Colour Foldout **pages 150-151**.

*\* Tooling charges may apply. Contact us to discuss your requirements.*

# Our Services

---

## SPECIFICATION SUPPORT



### SPECIFICATION DOCUMENTS

Need help with specification? Detailed specification texts for our products are available. Contact your local CS Office or download from our website.

### ACROVYN SHOWCASE

To help with the design process, we've developed Acrovyn Showcase app which allows you to visualise your wall protection designs. See **page 12** for more information.

### BIM OBJECTS

BIM Objects are available on request, contact your local CS office or visit our website.

### CUSTOM PRODUCTS/COLOURS

We understand that every project is unique and our standard designs may not always be suitable. We can work with you to design a bespoke solution that meets your project's specific requirements.

---

## KNOWLEDGE BANK



### PRODUCT PRESENTATIONS

CPD and Product Presentations are available either in person, via webinar or on-demand should you wish to learn more about relevant legislation and how our solutions can help you meet their requirements.

### WEBSITE

Our website features blogs and other educational content to help you specify and understand legislation requirements and case studies showcasing product applications across a range of market sectors.

---

## TECHNICAL SUPPORT



### PRODUCT SELECTION ADVICE

Our teams know our products inside out, and are available whenever you need them. Get in touch if you need advice on designing a protection scheme to suit your project, or relevant legislation requirements.

### DATASHEETS

Detailed datasheets for all our products are available via your local CS Office or our website.

### SITE VISITS

Site visits to advise on protection solutions, solve issues or measure up for accurate estimating can be booked. Contact your local CS Office for more information.

---

---

## SAMPLES



### PRODUCT SAMPLES

We can supply you with free of charge colour swatches and product samples to help you make the right choice for your project. These can either be ordered via our website or by contacting your local CS Office.

### VIRTUAL PRODUCT SAMPLES

We have developed digital samples of our products to allow you to view them in 3D, rotate and explode to see their component parts. See Acrovyn product pages on our website.

---

## FACTORY SERVICES



### CUTTING AND FORMING

We can deliver our products cut to custom lengths to spare you on-site cutting and allow for faster installations.

*Tolerances +/- 1 mm*

### PRE-FABRICATION

We do the assembly so you don't have to. We can deliver "ready to install" handrail assemblies to allow for speedy installations:

- Fast, clean and effortless installations
- No on-site cutting
- Fewer installation personnel needed

### EXTRUSION TO CUSTOM LENGTHS

We can extrude our profiles to lengths of your choice in order to minimise cutting waste.

*Minimum order of 150 meters per product – 4-5 weeks delivery. Gross manufacturing tolerances + 20 to + 40 mm extra length.*

### CUSTOM COLOURS

We can produce custom colours to suit your interior design scheme or brand, subject to minimum order quantities. Please contact your local CS Office for further details.

---

## INSTALLATION



### INSTALLATION INSTRUCTIONS

Installation instructions showcasing the optimal way of installing our products to ensure a quality end result are available from your local CS Office or our website.

### INSTALLATION SERVICES

We can manage the installation of our products for you, either through our own local installers or through our network of recommended contractors. Talk to your local CS Office to learn more about this service.

# Acrovyn®

## Colour Range



Discover  
our vibrant  
Acrovyn  
colour range



# Acrovyn® Colour Range

Our new palette of standard colours and decorative finishes offers designers limitless possibilities to enhance and protect any interior environment.

Colour availability varies across our wide range, so when selecting products to effectively protect your interiors refer to the table and detailed colour pages to find the right colours for your project.

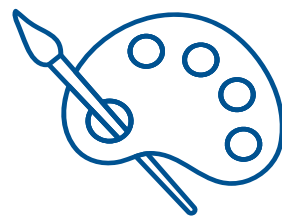
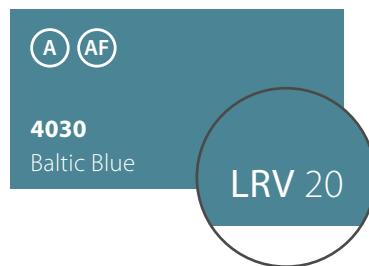

In the table on **page 149** we have included a handy guide to the nearest matches to RAL, RAL Design and NCS colours, so that you can ensure wall protection either matches or sufficiently contrasts with other interior surfaces and decor elements.

We have also provided Light Reflectance Values (LRVs)\* for all solid colours and finishes to help you design all-inclusive schemes, which consider the needs of users with visual impairment (for further guidance on this see **page 18**).

We understand that our standard range may not provide you with perfect choices to fit your design vision, so we can produce bespoke colours for you, subject to minimum quantities. Contact us to discuss your requirements.

Explore the full range of our colour and finishes on **pages 150-152**.

## COLOUR SAMPLE SERVICE

Due to limitations of print and computer screens, actual Acrovyn colours may vary. If colour selection is important on your project, take advantage of our free-of-charge colour sample service.

Please contact your local CS Office or visit our website to request your colour samples.



\*Light Reflectance Value (LRV) indicates the amount of light reflected by a surface and can be used to assess the degree of visual contrast between different surfaces. LRV values for our colours and finishes have been determined using the CIE Y value measurement method.

# WALL PROTECTION COLOUR AVAILABILITY

WALL PROTECTION COLOUR AVAILABILITY				Acrovyn Textured Sheet	Acrovyn PVC-Free Textured Sheet	Acrovyn Smooth Sheet	Acrovyn Bactericide Sheet Textured	SO, TF-N and TP Models	Acrovyn Profiles	Acrovyn PVC-Free Profiles
Code	Colour / Finishes	RAL / RAL Design	NCS							
9003	Snow White	9003	S 0500-N	●	●	●	● †	●	●	
9010	Pure White	9010	S 0502-6	●	●	●	●	●		
949	White	9003	S 0300-N							●
933	Mission White	9001	S 1002-Y50R	●	●			●		●
100	Eggshell	1013	S 1005-Y10R	●	●			●	●	●
801	Grey Cloud	080 60 05	S 1502-Y50R	●	●	●	●	●	●	
187	Tan Bark	070 70 10	S 3005-Y50R	●	●			●	●	●
26	Taupe	060 50 05	S 5005-Y80R	●	●			●	●	
8019	Earth	8019	S 8005-Y80R	●	●			●		
7044	Felt	7044	S 2502-Y	●	●			●	●	
136	Pearl Grey	7004	S 3500-N	●	●			●	●	●
162	Charcoal	7037	S 5500-N	●	●			●	●	●
7043	Anthracite	7043	S 7000-N	●	●			●	●	
260	Misty Grey	280 90 05	S 0505-R80B	●	●			●	●	●
24	Dove Grey	200 70 05	S 2502-B	●	●	●	●	●	●	
7024	Graphite	7024	S 7502-B	●	●			●		
108	Black	7021	S 8000-N	●	●			●	●	●
11	Aqua Blue	250 80 20	S 1030-R90B	●	●	●	●	●		
325	Cape Blue	240 60 15	S 3020-R90B	●	●			●	●	
112	Pacific Blue	5012	S 1560-R90B	●	●			●	●	
520	Imperial Purple	290 50 15	S 5020-R60B	●	●			●	●	
1015	Ice Blue	260 80 10	S 1015-R80B	●	●	●		●	●	
5018	Lagoon	5018	S 2050-B30G	●	●			●		
4030	Baltic Blue	230 50 20	S 4030-B10G	●	●			●	●	●
129	Yale Blue	5001	S 6030-R90B	●	●			●	●	●
1510	Almond Green	180 80 05	S 1510-B80G	●	●	●	●	●	●	
22	Anise	110 80 40	S 1040-G40Y	●	●			●		
3040	Prairie Green	130 60 30	S 3040-G30Y	●	●			●	●	
6020	Sequoia Green	200 40 10	S 6020-B50G	●	●			●	●	
101	French Cream	1015	S 1010-Y20R	●	●	●		●	●	●
16	Golden Yellow	080 80 70	S 0560-Y10R	●	●			●	●	●
17	Tangerine	060 70 70	S 1060-Y30R	●	●			●	●	
845	Spectrum Red	3020	S 2070-Y90R	●	●			●	●	●
510	Powder Pink	350 90 05	S 0507-R20B	●	●	●		●	●	●
2040	Coral Blush	020 60 30	S 2040-R	●	●	●		●		
2050	Pink Grapefruit	030 60 40	S 2050-Y80R	●	●			●	●	
32	Sugar Plum	350 30 30	S 4040-R30B	●	●			●		●
51	Natural Oak			●				● *	● **	
36	Bleached Oak			●				● *	● **	
52	Golden Oak			●				● *	● **	
53	Walnut			●				● *	● **	
38	Smoked Oak			●				● *	● **	
39	Wenge			●				● *	● **	
54	Grey Concrete			●				● *	● **	
55	Taupe Concrete			●				● *	● **	
56	Black Concrete			●				● *	● **	
06	Brushed Metal			●				● *	● **	
57	Bronze			●				● *	● **	
58	Copper			●				● *	● **	

† Smooth option available \* SO-50 Models only \*\* Select Models



# Acrovyn® Sheet

## SOLID COLOURS

### Key

- (A)** Acrovyn 2mm or 1mm; Suede Texture (36)
- (AF)** Acrovyn PVC-Free 1.5mm or 1mm; Suede Texture (36)

- (AS)** Acrovyn 2mm; Smooth (10)
- (BT)** Acrovyn Bactericide 2mm; Suede Texture (6)
- (BS)** Acrovyn Bactericide 2mm; Smooth (1)

<p>(A) (AF) (AS) (BT) (BS)</p> <p><b>9003</b> Snow White LRV 86</p>	<p>(A) (AF) (AS) (BT)</p> <p><b>9010</b> Pure White LRV 83</p>	<p>(A) (AF)</p> <p><b>933</b> Mission White LRV 74</p>	<p>(A) (AF)</p> <p><b>100</b> Eggshell LRV 73</p>
<p>(A) (AF) (AS) (BT)</p> <p><b>801</b> Grey Cloud LRV 64</p>	<p>(A) (AF)</p> <p><b>187</b> Tan Bark LRV 40</p>	<p>(A) (AF)</p> <p><b>26</b> Taupe LRV 24</p>	<p>(A) (AF)</p> <p><b>8019</b> Earth LRV 7</p>
<p>(A) (AF)</p> <p><b>7044</b> Felt LRV 50</p>	<p>(A) (AF)</p> <p><b>136</b> Pearl Grey LRV 39</p>	<p>(A) (AF)</p> <p><b>162</b> Charcoal LRV 22</p>	<p>(A) (AF)</p> <p><b>7043</b> Anthracite LRV 14</p>
<p>(A) (AF)</p> <p><b>260</b> Misty Grey LRV 80</p>	<p>(A) (AF) (AS) (BT)</p> <p><b>24</b> Dove Grey LRV 49</p>	<p>(A) (AF)</p> <p><b>7024</b> Graphite LRV 10</p>	<p>(A) (AF)</p> <p><b>108</b> Black LRV 8</p>
<p>(A) (AF) (AS) (BT)</p> <p><b>11</b> Aqua Blue LRV 50</p>	<p>(A) (AF)</p> <p><b>325</b> Cape Blue LRV 32</p>	<p>(A) (AF)</p> <p><b>112</b> Pacific Blue LRV 24</p>	<p>(A) (AF)</p> <p><b>520</b> Imperial Purple LRV 16</p>
<p>(A) (AF) (AS)</p> <p><b>1015</b> Ice Blue LRV 63</p>	<p>(A) (AF)</p> <p><b>5018</b> Lagoon LRV 31</p>	<p>(A) (AF)</p> <p><b>4030</b> Baltic Blue LRV 20</p>	<p>(A) (AF)</p> <p><b>129</b> Yale Blue LRV 8</p>
<p>(A) (AF) (AS) (BT)</p> <p><b>1510</b> Almond Green LRV 60</p>	<p>(A) (AF)</p> <p><b>22</b> Anise LRV 56</p>	<p>(A) (AF)</p> <p><b>3040</b> Prairie Green LRV 29</p>	<p>(A) (AF)</p> <p><b>6020</b> Sequoia Green LRV 13</p>
<p>(A) (AF) (AS)</p> <p><b>101</b> French Cream LRV 70</p>	<p>(A) (AF)</p> <p><b>16</b> Golden Yellow LRV 66</p>	<p>(A) (AF)</p> <p><b>17</b> Tangerine LRV 47</p>	<p>(A) (AF)</p> <p><b>845</b> Spectrum Red LRV 15</p>
<p>(A) (AF) (AS)</p> <p><b>510</b> Powder Pink LRV 79</p>	<p>(A) (AF) (AS)</p> <p><b>2040</b> Coral Blush LRV 31</p>	<p>(A) (AF)</p> <p><b>2050</b> Pink Grapefruit LRV 28</p>	<p>(A) (AF)</p> <p><b>32</b> Sugar Plum LRV 13</p>

# Acrovyn® Sheet & Profiles

## DECORATIVE FINISHES

### Key

- (A)** Acrovyn Sheet 2mm;  
Suede Texture (12)
- (AP)** Acrovyn Profiles  
(select models) (12)

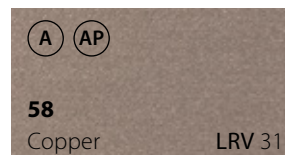
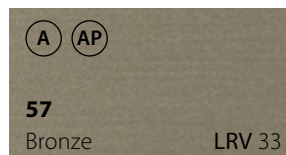
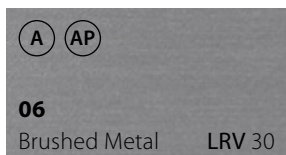
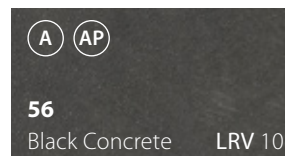
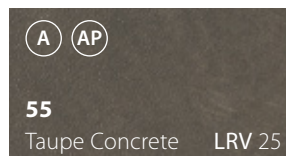
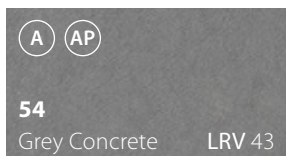
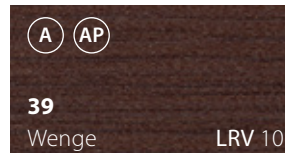
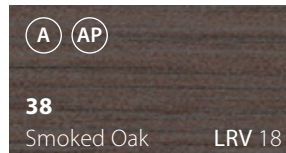
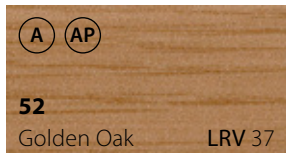
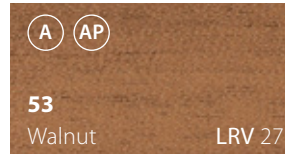
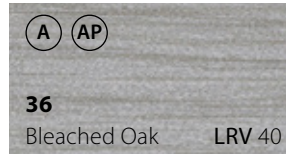
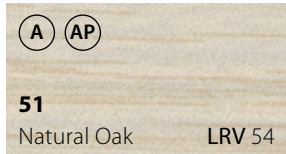

Acrovyn Finishes can be specified for 2mm Acrovyn Sheet and a selection of Acrovyn Profiles:

SSM-20 Corner Guards  
**Page 65**

SO-50 Corner Guards  
**Page 67**

HRE-6 Handrails  
**Page 76**

HRO-6 Handrails  
**Page 81**

HRB-20 Hand/ Crash Rails (handrail section only)  
**Page 86**

SCR-80 Crash Rails  
**Page 96**

# Acrovyn® Timber Handrails

## TIMBER AND VARNISH OPTIONS

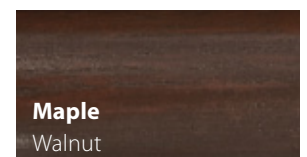
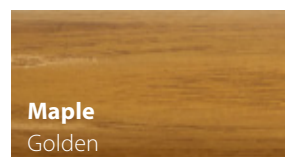
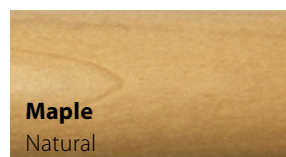
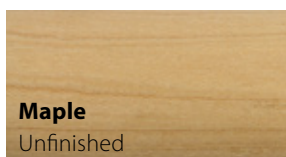
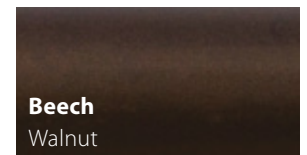
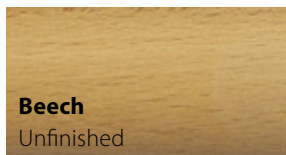
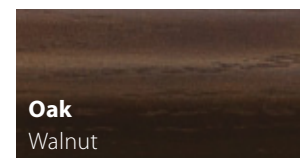
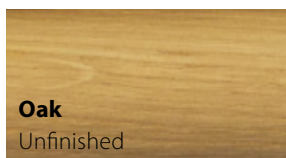

# Acrovyn® Profiles

## SOLID COLOURS

### Key

- A Acrovyn; Shadowgrain Texture (27)
- AF Acrovyn PVC-Free; Shadowgrain Texture (15)

<span style="border: 1px solid black; border-radius: 50%; padding: 2px;">A</span> <b>9003</b> Snow White LRV 86	<span style="border: 1px solid black; border-radius: 50%; padding: 2px;">AF</span> <b>949</b> White LRV 90	<span style="border: 1px solid black; border-radius: 50%; padding: 2px;">AF</span> <b>933</b> Mission White LRV 74	<span style="border: 1px solid black; border-radius: 50%; padding: 2px;">A</span> <span style="border: 1px solid black; border-radius: 50%; padding: 2px;">AF</span> <b>100</b> Eggshell LRV 73
<span style="border: 1px solid black; border-radius: 50%; padding: 2px;">A</span> <b>801</b> Grey Cloud LRV 64	<span style="border: 1px solid black; border-radius: 50%; padding: 2px;">A</span> <span style="border: 1px solid black; border-radius: 50%; padding: 2px;">AF</span> <b>187</b> Tan Bark LRV 40	<span style="border: 1px solid black; border-radius: 50%; padding: 2px;">A</span> <b>26</b> Taupe LRV 24	<span style="border: 1px solid black; border-radius: 50%; padding: 2px;">A</span> <b>7044</b> Felt LRV 50
<span style="border: 1px solid black; border-radius: 50%; padding: 2px;">A</span> <span style="border: 1px solid black; border-radius: 50%; padding: 2px;">AF</span> <b>260</b> Misty Grey LRV 80	<span style="border: 1px solid black; border-radius: 50%; padding: 2px;">A</span> <b>24</b> Dove Grey LRV 49	<span style="border: 1px solid black; border-radius: 50%; padding: 2px;">A</span> <span style="border: 1px solid black; border-radius: 50%; padding: 2px;">AF</span> <b>136</b> Pearl Grey LRV 39	<span style="border: 1px solid black; border-radius: 50%; padding: 2px;">A</span> <span style="border: 1px solid black; border-radius: 50%; padding: 2px;">AF</span> <b>162</b> Charcoal LRV 22
<span style="border: 1px solid black; border-radius: 50%; padding: 2px;">A</span> <b>7043</b> Anthracite LRV 14	<span style="border: 1px solid black; border-radius: 50%; padding: 2px;">A</span> <span style="border: 1px solid black; border-radius: 50%; padding: 2px;">AF</span> <b>108</b> Black LRV 8		
<span style="border: 1px solid black; border-radius: 50%; padding: 2px;">A</span> <b>1015</b> Ice Blue LRV 63	<span style="border: 1px solid black; border-radius: 50%; padding: 2px;">A</span> <b>112</b> Pacific Blue LRV 24	<span style="border: 1px solid black; border-radius: 50%; padding: 2px;">A</span> <b>325</b> Cape Blue LRV 32	<span style="border: 1px solid black; border-radius: 50%; padding: 2px;">A</span> <span style="border: 1px solid black; border-radius: 50%; padding: 2px;">AF</span> <b>129</b> Yale Blue LRV 8
<span style="border: 1px solid black; border-radius: 50%; padding: 2px;">A</span> <b>1510</b> Almond Green LRV 60	<span style="border: 1px solid black; border-radius: 50%; padding: 2px;">A</span> <b>3040</b> Prairie Green LRV 29	<span style="border: 1px solid black; border-radius: 50%; padding: 2px;">A</span> <b>6020</b> Sequoia Green LRV 13	<span style="border: 1px solid black; border-radius: 50%; padding: 2px;">A</span> <span style="border: 1px solid black; border-radius: 50%; padding: 2px;">AF</span> <b>4030</b> Baltic Blue LRV 20
<span style="border: 1px solid black; border-radius: 50%; padding: 2px;">A</span> <span style="border: 1px solid black; border-radius: 50%; padding: 2px;">AF</span> <b>101</b> French Cream LRV 70	<span style="border: 1px solid black; border-radius: 50%; padding: 2px;">A</span> <span style="border: 1px solid black; border-radius: 50%; padding: 2px;">AF</span> <b>16</b> Golden Yellow LRV 66	<span style="border: 1px solid black; border-radius: 50%; padding: 2px;">A</span> <b>17</b> Tangerine LRV 47	<span style="border: 1px solid black; border-radius: 50%; padding: 2px;">A</span> <span style="border: 1px solid black; border-radius: 50%; padding: 2px;">AF</span> <b>845</b> Spectrum Red LRV 15
<span style="border: 1px solid black; border-radius: 50%; padding: 2px;">A</span> <span style="border: 1px solid black; border-radius: 50%; padding: 2px;">AF</span> <b>510</b> Powder Pink LRV 79	<span style="border: 1px solid black; border-radius: 50%; padding: 2px;">A</span> <b>2050</b> Pink Grapefruit LRV 28	<span style="border: 1px solid black; border-radius: 50%; padding: 2px;">AF</span> <b>32</b> Sugar Plum LRV 13	<span style="border: 1px solid black; border-radius: 50%; padding: 2px;">A</span> <b>520</b> Imperial Purple LRV 16

## CS SOLUTIONS:

**Acrovyn®** Wall & Door Protection

**Acrovyn by Design®** Bespoke Wall Protection

**Acrovyn® Doors** Impact Resistant Doorsets

**Pedisystems®** Entrance Matting

**Wallglaze®** Performance Coatings

**Supertrak® Plus** Cubicle Curtain Track

**Omniwall®** Interior Partitions

**Expansion Joint Covers**

**Architectural Louvres**

**Airfoil®** Solar Shading

**Explovent®** Explosion Venting

**APC Dayliter™** Fire and Smoke Vents

**Dexpale™** Lighting Displays

## CS FRANCE

135, Rue Edouard Isambard  
B.P. 66 | 27120 PACY/EURE  
FRANCE

Tel: +33 2 32 67 00 00  
information@c-sgroup.com  
www.c-sgroup.eu

